

AVENTICS Guide units



Technical data

| | |
|--------------------------|---------------|
| Industry | Industrial |
| Piston Ø | 63 mm |
| Stroke | 400 mm |
| Bearing type | Plain bearing |
| For standard cylinders | ISO 15552 |
| Min. ambient temperature | -20 °C |
| Max. ambient temperature | 80 °C |
| Weight 0 mm stroke | 4.7 kg |
| Weight +10 mm stroke | 0.025 kg |

Material

| | |
|--|-----------------------------|
| Bearing housings | Aluminum |
| Surface bearing housing | colorless anodized |
| Bearing type | Sintered bronze |
| Carrying plate | Aluminum |
| Surface carrying plate | colorless anodized |
| Material flexible coupling in carrying plate | Stainless Steel |
| Material guide rods | Hardened heat-treated steel |
| Surface guide rods | ground |

Guide unit GH1, Series CG1

0821401287

Guide units

2023-12-06

Part No.

0821401287

Dimensions

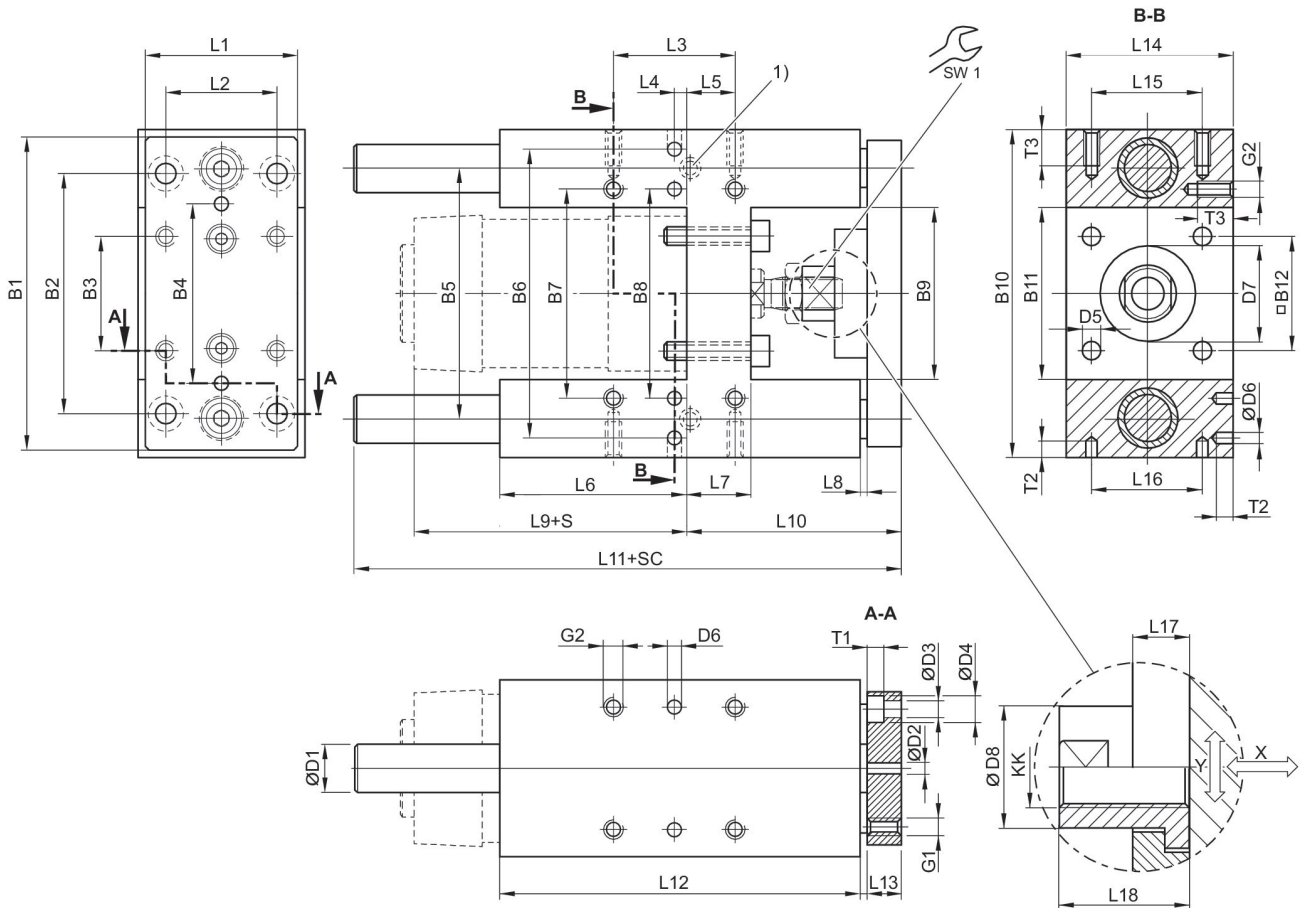

- 1) Lube nipple
- S = stroke
- SC = cylinder stroke
- X = max. play (axial)
- Y = min. play (radial)

| Piston Ø | B1 | B2 | B3 | B4 | B5 | B6 | B7 | B8 | B9 |
|----------|-----|-----|------|-----|-----|-----|-----|-----|-------|
| 32 | 90 | 78 | 32.5 | 50 | 74 | 81 | 61 | 61 | 50.2 |
| 40 | 110 | 84 | 38 | 54 | 87 | 99 | 69 | 69 | 58.2 |
| 50 | 130 | 100 | 46.5 | 72 | 104 | 119 | 85 | 85 | 70.2 |
| 63 | 145 | 105 | 56.5 | 82 | 119 | 132 | 100 | 100 | 85.2 |
| 80 | 180 | 130 | 72 | 106 | 148 | 166 | 130 | 130 | 105.4 |
| 100 | 200 | 150 | 89 | 131 | 172 | 190 | 150 | 150 | 130.4 |

| Piston Ø | B10 | B11 | B12 | D1 | D2 H7 | D3 | D4 | D5 | D6 H7 |
|----------|-----|------|------|----|-------|-----|----|-----|-------|
| 32 | 97 | 50.2 | 32.5 | 12 | 6 | 6.6 | 11 | 6.6 | 6 |
| 40 | 115 | 58.2 | 38 | 16 | 6 | 6.6 | 11 | 6.6 | 6 |

| Piston Ø | B10 | B11 | B12 | D1 | D2 H7 | D3 | D4 | D5 | D6 H7 |
|----------|-----|-------|------|----|-------|----|----|----|-------|
| 50 | 137 | 70.2 | 46.5 | 20 | 6 | 9 | 15 | 9 | 6 |
| 63 | 152 | 85.2 | 56.5 | 20 | 6 | 9 | 15 | 9 | 6 |
| 80 | 189 | 105.4 | 72 | 25 | 6 | 11 | 18 | 11 | 6 |
| 100 | 213 | 130.4 | 89 | 25 | 6 | 11 | 18 | 11 | 6 |

| Piston Ø | D7 M8 | D8 | G1 | G2 | KK | L1 | L2 | L3 | L4 |
|----------|-------|------|-----|-----|----------|-----|------|------|-----|
| 32 | 30 | 14.5 | M6 | M6 | M10x1,25 | 45 | 32.5 | 32.5 | 12 |
| 40 | 35 | 18 | M6 | M6 | M12x1,25 | 54 | 38 | 38 | 8 |
| 50 | 40 | 24 | M8 | M8 | M16x1,5 | 63 | 46.5 | 46.5 | 4.5 |
| 63 | 45 | 24 | M8 | M8 | M16x1,5 | 80 | 56.5 | 56.5 | 13 |
| 80 | 45 | 30 | M10 | M10 | M20x1,5 | 100 | 72 | 72 | 15 |
| 100 | 55 | 30 | M10 | M10 | M20x1,5 | 120 | 89 | 89 | 20 |

| Piston Ø | L5 | L6 | L7 | L8 | L9 | L10 | L11 | L12 | L13 |
|----------|-------|-----|----|----|-----|-----|-------|-----|-----|
| 32 | 4.25 | 76 | 17 | 3 | 94 | 64 | 177.5 | 125 | 12 |
| 40 | 11 | 81 | 21 | 3 | 105 | 74 | 192.5 | 140 | 12 |
| 50 | 18.75 | 79 | 26 | 3 | 106 | 89 | 205 | 150 | 15 |
| 63 | 15.25 | 111 | 26 | 3 | 121 | 89 | 237 | 182 | 15 |
| 80 | 21 | 128 | 34 | 3 | 128 | 110 | 280 | 215 | 20 |
| 100 | 24.5 | 128 | 39 | 3 | 138 | 115 | 280 | 220 | 20 |

| Piston Ø | L14 | L15 | L16 | L17 | L18 | T1 | T2 | T3 | SW1 |
|----------|-----|------|------|-----|-----|-----|----|----|-----|
| 32 | 50 | 32.5 | 32.5 | 6 | 17 | 6.5 | 10 | 15 | 13 |
| 40 | 58 | 38 | 38 | 14 | 22 | 6.5 | 10 | 15 | 15 |
| 50 | 70 | 46.5 | 46.5 | 14 | 26 | 9 | 10 | 16 | 22 |
| 63 | 85 | 56.5 | 56.5 | 14 | 26 | 9 | 10 | 16 | 22 |
| 80 | 105 | 72 | 72 | 14 | 32 | 11 | 10 | 20 | 27 |
| 100 | 130 | 89 | 89 | 14 | 32 | 11 | 10 | 20 | 27 |

Bending due to 10 N load

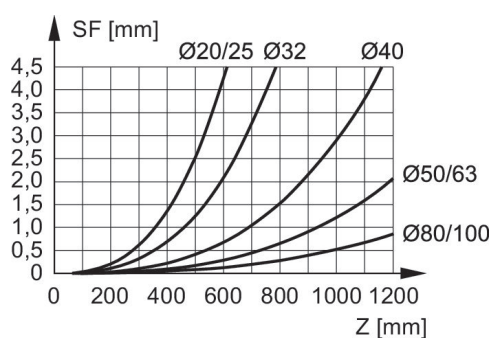

F = useful load (at the load center), SF = bending, Z = projection

Bending due to own load

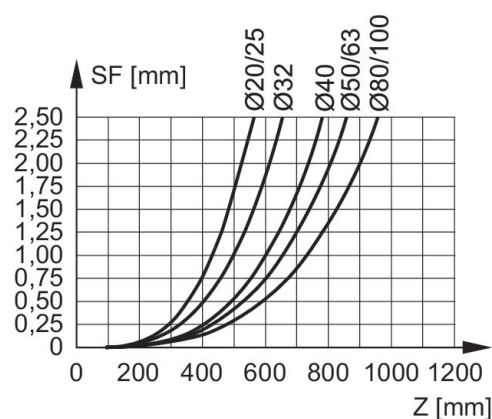

F = useful load (at the load center), SF = bending, Z = projection

Bending due to 10 N load

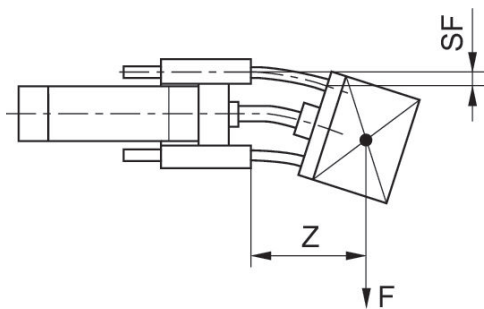

F = useful load (at the load center), SF = bending, Z = projection

Useful load

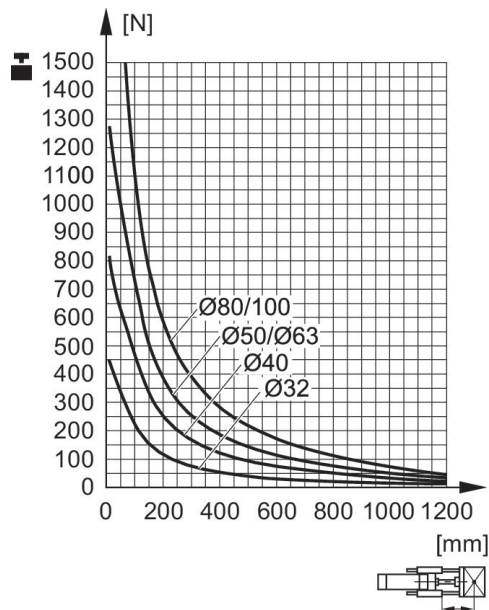

F = Useful load, Z = Projection

Useful load

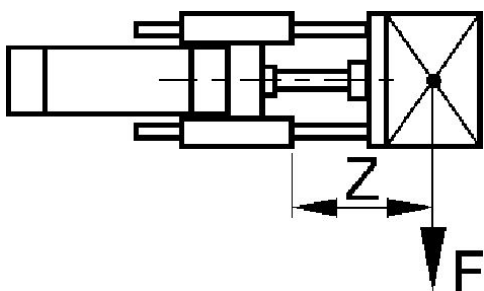

F = Useful load, Z = Projection