

AVENTICS Guide units



Technical data

Industry	Industrial
Piston Ø	100 mm
Stroke	200 mm
Bearing type	Plain bearing
For standard cylinders	ISO 15552
Min. ambient temperature	-20 °C
Max. ambient temperature	80 °C
Weight 0 mm stroke	11.1 kg
Weight +10 mm stroke	0.039 kg

Material

Bearing housings	Aluminum
Surface bearing housing	colorless anodized
Bearing type	Sintered bronze
Carrying plate	Aluminum
Surface carrying plate	colorless anodized
Material flexible coupling in carrying plate	Stainless Steel
Material guide rods	Hardened heat-treated steel
Surface guide rods	ground

Guide unit GH1, Series CG1

0821401271

Guide units

2023-12-06

Part No.

0821401271

Dimensions

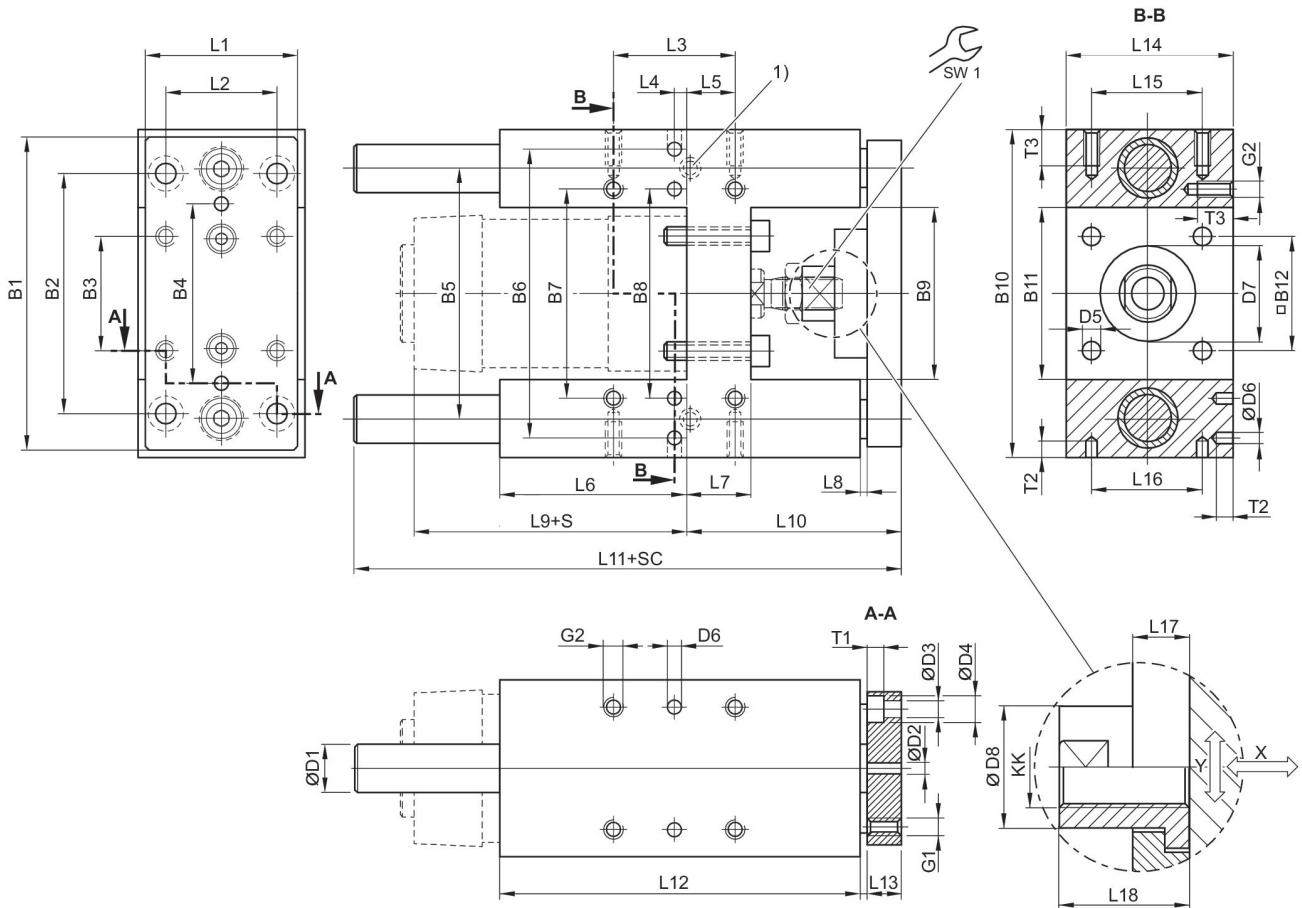

- 1) Lube nipple
- S = stroke
- SC = cylinder stroke
- X = max. play (axial)
- Y = min. play (radial)

Piston Ø	B1	B2	B3	B4	B5	B6	B7	B8	B9
32	90	78	32.5	50	74	81	61	61	50.2
40	110	84	38	54	87	99	69	69	58.2
50	130	100	46.5	72	104	119	85	85	70.2
63	145	105	56.5	82	119	132	100	100	85.2
80	180	130	72	106	148	166	130	130	105.4
100	200	150	89	131	172	190	150	150	130.4

Piston Ø	B10	B11	B12	D1	D2 H7	D3	D4	D5	D6 H7
32	97	50.2	32.5	12	6	6.6	11	6.6	6
40	115	58.2	38	16	6	6.6	11	6.6	6

Piston Ø	B10	B11	B12	D1	D2 H7	D3	D4	D5	D6 H7
50	137	70.2	46.5	20	6	9	15	9	6
63	152	85.2	56.5	20	6	9	15	9	6
80	189	105.4	72	25	6	11	18	11	6
100	213	130.4	89	25	6	11	18	11	6

Piston Ø	D7 M8	D8	G1	G2	KK	L1	L2	L3	L4
32	30	14.5	M6	M6	M10x1,25	45	32.5	32.5	12
40	35	18	M6	M6	M12x1,25	54	38	38	8
50	40	24	M8	M8	M16x1,5	63	46.5	46.5	4.5
63	45	24	M8	M8	M16x1,5	80	56.5	56.5	13
80	45	30	M10	M10	M20x1,5	100	72	72	15
100	55	30	M10	M10	M20x1,5	120	89	89	20

Piston Ø	L5	L6	L7	L8	L9	L10	L11	L12	L13
32	4.25	76	17	3	94	64	177.5	125	12
40	11	81	21	3	105	74	192.5	140	12
50	18.75	79	26	3	106	89	205	150	15
63	15.25	111	26	3	121	89	237	182	15
80	21	128	34	3	128	110	280	215	20
100	24.5	128	39	3	138	115	280	220	20

Piston Ø	L14	L15	L16	L17	L18	T1	T2	T3	SW1
32	50	32.5	32.5	6	17	6.5	10	15	13
40	58	38	38	14	22	6.5	10	15	15
50	70	46.5	46.5	14	26	9	10	16	22
63	85	56.5	56.5	14	26	9	10	16	22
80	105	72	72	14	32	11	10	20	27
100	130	89	89	14	32	11	10	20	27

Bending due to 10 N load

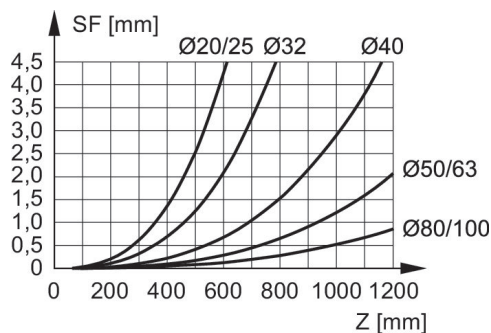

F = useful load (at the load center), SF = bending, Z = projection

Bending due to own load

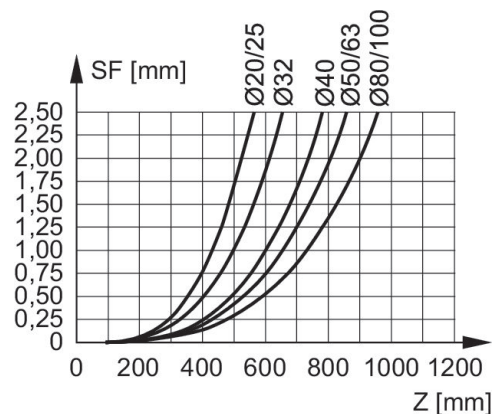

F = useful load (at the load center), SF = bending, Z = projection

Bending due to 10 N load

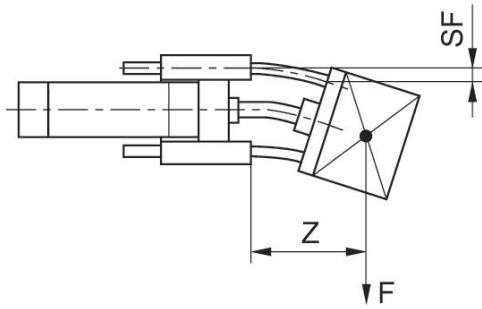

F = useful load (at the load center), SF = bending, Z = projection

Useful load

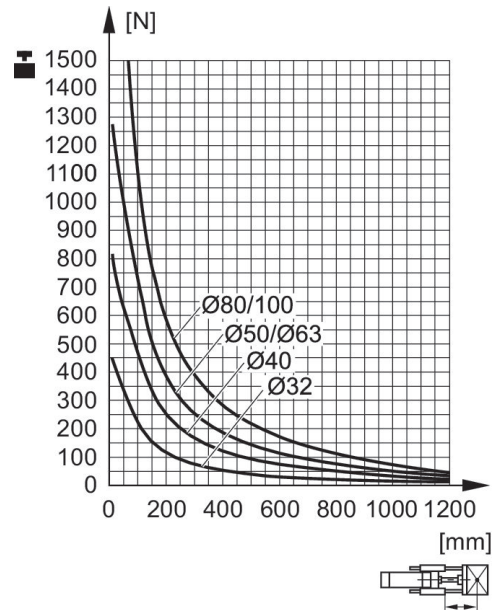

F = Useful load, Z = Projection

Useful load

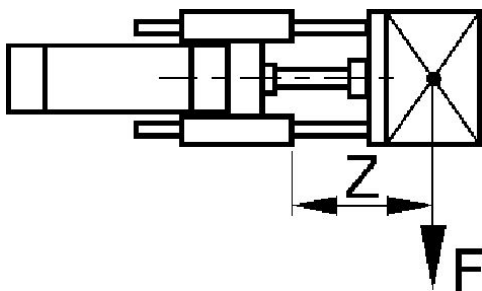

F = Useful load, Z = Projection