

Rodless cylinders, Series CKP

R480163964

AVENTICS
Series CKP
Rodless
cylinders

2024-03-19

AVENTICS Series CKP Rodless cylinders

The AVENTICS Series CKP cylinders provide sturdy, ultra-precise guiding with excellent repeatability and are ideal for applications requiring the movement of heavy loads in space-critical machine environments.

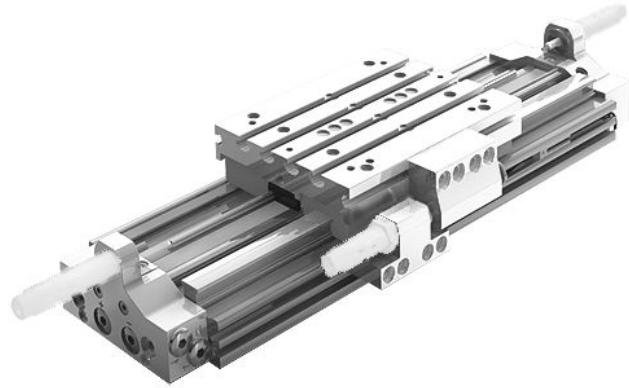

Technical data

Industry	Industrial
Piston Ø	32 mm
Stroke	700 mm
Ports	G 1/8
Functional principle	Double-acting
Magnetic piston	with magnetic piston
Guide	ball rail guide
Easy2Combine	Easy2Combine capable with connection kit
Piston force	507 N
Pressure for determining piston forces	6,3 bar
Cushioning length	20 mm
Cushioning energy	7 J
Cushioning	Pneumatically
Cushioning	adjustable
Max. speed	2 m/s
Stroke max.	3700 mm
Min. working pressure	3 bar
Max. working pressure	8 bar
Min. ambient temperature	-10 °C

Rodless cylinders, Series CKP

R480163964

AVENTICS
Series CKP
Rodless
cylinders

2024-03-19

Max. ambient temperature	60 °C
Min. medium temperature	-10 °C
Max. medium temperature	60 °C
Medium	Compressed air
Max. particle size	5 µm
Weight	15.12 kg

Material

Material front cover	Aluminum
Surface cover	anodized
Seal material	Polyurethane
Material sealing strips	Polyurethane Stainless Steel
Material guide rail	Aluminum
Surface ball rail table	anodized
Material guide rail	Steel, chrome-plated
Surface guide rail	hardened
Part No.	R480163964

Technical information

The pressure dew point must be at least 15 °C less than ambient and medium temperature and may not exceed 3 °C.

The delivered product is lubricated for lifetime.

This product may only be operated with oil-free, dry compressed air.

SA = stroke adjustment with use of shock absorber. Adjustment made with adjustment screw. Shock absorber can be replaced without readjustment of end position.

The pressure dew point must be at least 15 °C less than ambient and medium temperature and may not exceed 3 °C.

The oil content of compressed air must remain constant during the life cycle.

Use only the approved oils from AVENTICS. Further information can be found in the "Technical information" document (available in <https://www.emerson.com/en-us/support>).

Rodless cylinders, Series CKP

R480163964

AVENTICS
Series CKP
Rodless
cylinders

2024-03-19

Dimensions



t = depth

* CKP 16: 2x Lube ports on each runner block, CKP 25 / 30: Lube nipple of funnel type with thread connection M3

Piston Ø	B	Ø RW t = depth of thread	RX t = depth of thread	GX	E	BU	CC	EE	FH
16	90	9 H7 t=2,1	M4 t=7,5	38	27.3	125	28	M7	56
25	110	9 H7 t=2,1	M5 t=9	46	31.4	155	28	G 1/8	66
32	145	12 H7 t=2,1	M6 t=13	62	37.8	190	28	G 1/8	85

Piston Ø	GA	GB	GC	GD	GN	GE	GF	GH	GI
16	15	20	20	20	93.5	38.5	110	20	40
25	25	20	20	20	107.5	47.5	120	42	80
32	19	40	27	40	120	40	160	35	80

Piston Ø	GJ	GK	GL	GM	GT	GU	MC	PL	PM
16	40	60	80	-	57	80	93.5	8	21

Rodless cylinders, Series CKP

R480163964

AVENTICS
Series CKP
Rodless
cylinders

Piston Ø	GJ	GK	GL	GM	GT	GU	MC	PL	PM
25	40	60	80	–	66	106	107.5	8	20
32	40	80	120	80	88	111	120	8	19

Piston Ø	PO	PP	PS	PT	PU	PW	Q1	Q2	Q3
16	12.8	6.8	33	29.8	6.8	6	73.5	40	–
25	22	10.5	37.5	24	10.5	10.5	87.5	40	12.5
32	23.8	10.3	57	51	12	12	100	40	12.5

Piston Ø	RG	Ø RP	RQ t = depth of thread	Ø RR	Ø RS	RT	Ø RU	SG	SL
16	M5	9 F7	M5 t=10,5	4 F7	9 F7	M6	12 F7	20.3	43
25	M5	9 F7	M6 t=14,5	5 F7	12 F7	M6	12 F7	14	60
32	M6	12 F7	M6 t=14,5	6 F7	12 F7	M6	12 F7	32.5	60

Piston Ø	SU	SW	T	TT	W1	W2	T1	ZD	SA
16	37	20	M4	N6	112	102	16	187	0–10
25	43	23	N6	N6	140	126	20	215	0–10
32	59	23	N6	N8	175	161	23	240	0–10

Piston Ø	Moving mass kg
16	0.64
25	1.11
32	2.62

Permissible forces F_x , F_y , F_z and torques M_x , M_y , M_z

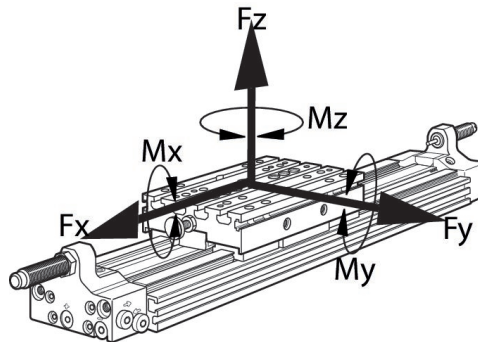

With simultaneously moments on the cylinder this equation must be used in addition to the maximum moments check. In the cushioning phase of the

movement additional forces occur and must be considered. Please use our calculation tool for rodless cylinders on the <http://www.aventics.com>.

Max. dynamic forces and torques

Piston Ø	F_x [N]	F_y [N]	F_z [N]	M_x [Nm]	M_y [Nm]	M_z [Nm]
16	2912	2912	2912	83	116	143
25	3280	3280	8568	283	454	205
32	5280	5280	15620	687	867	374

Recommended values for an expected lifetime of 3200 km