

Clevis mounting AB3, Series CM1

5217123402

Clevis
mounting

2024-03-26

AVENTICS Clevis mountings



Technical data

Industry

Industrial

For series

RPC

Piston diameter

50 mm

Material

Material

Galvanized Steel

Part No.

5217123402

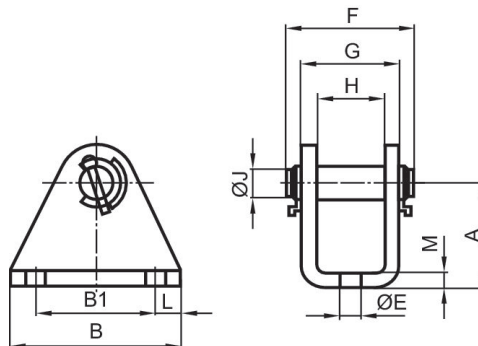

Clevis mounting AB3, Series CM1

5217123402

Clevis
mounting

2024-03-26

Piston Ø	Part No.	A	B	B1	Ø E	F	G	H	Ø J
32	5217103402	35	55	35	9	55	35.1	25.1	10
40	5217113402	40	55	35	9	65	40.1	30.1	12
50	5217123402	50	55	35	11	75	51.1	35.1	12
63	5217133402	60	65	45	11	75	51.1	35.1	16

Piston Ø	L	M
32	10	5
40	10	5
50	10	8
63	10	8