

Bearing AT4, Series CM1

R412018903

Trunnion
mountings

2023-10-26

AVENTICS Trunnion mountings



Technical data

Industry	Industrial
Version	for trunnion mounting MT4, MT5, MT6
For series	ITS
Standardization	ISO 15552
Piston diameter	320 mm
Swivel bearing Ø	40 mm
Delivery unit	2 piece

Material

Housing material	Steel, chrome-plated
Surface housing	galvanized
Material guide bushing	Sintered bronze
Part No.	R412018903

Bearing AT4, Series CM1

R412018903

Trunnion
mountings

2023-10-26

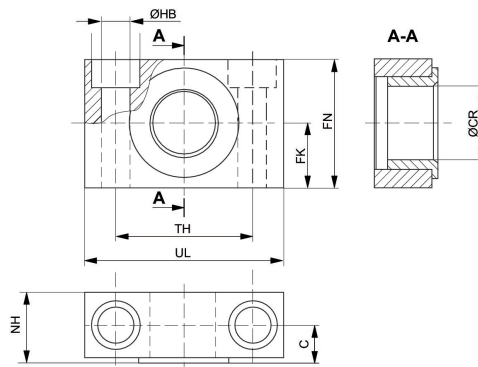

Piston Ø	Part No.	UL	NH	TH	C	CR H9	HB H13	FN	FK
20, 25, 32	1827001603	46	18	32 ±0,2	10.5	12	6.6	30	15 ±0,1
40, 50	1827001604	55	21	36 ±0,2	12	16	9	36	18 ±0,1
63, 80	1827001605	65	23	42 ±0,2	13	20	11	40	20 ±0,1
100, 125	1827001606	75	28.5	50 ±0,2	16	25	14	50	25 ±0,1
160, 200	1827001607	92	40	60 ±0,3	22.5	32	18	60	30 ±0,2
250	1827001608	140	50	90 ±0,3	27.5	40	22	70	35 ±0,2
320	R412018903	150	60	100	32.5	50	26	80	40