

# Bearing blocks, Series ICS

2992112060

Bearing  
block

2023-11-14

## AVENTICS Bearing blocks



### Technical data

Industry

Industrial

Piston diameter

63 mm

### Material

Housing material

Stainless Steel

Surface housing

acid-proof

Material guide bushing

Plastic

Part No.

2992112060

Dimensions

# Bearing blocks, Series ICS

2992112060

Bearing  
block

2023-11-14

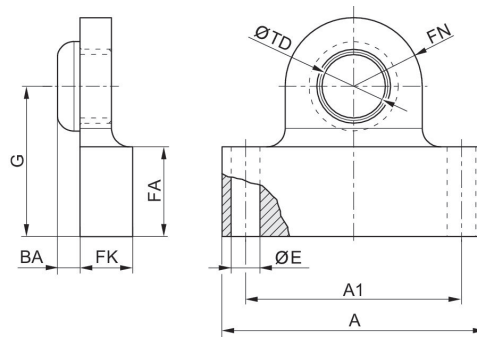

Piston Ø	Part No.	A	A1	BA	Ø E	FA	FK	FN	G
32	2992112030	50	41	4.25	5.5	17	10	13	28.5
40	2992112040	55	46	4.25	5.5	17	10	15.5	38
50	2992112050	64	53	5.25	6.5	18.5	12	17.5	38
63	2992112060	66	56	8.25	6.5	18.5	12	19	46.5
80	2992112080	82	72	8.25	6.5	18.5	12	26	50.5
100	2992112100	108	88	10.25	9	22	16	26	65

Piston Ø	Ø TD h9
32	12
40	12
50	16
63	16
80	16
100	20