

# Intermediate flange JP1, Series CM1

1827020248

General series information  
AVENTICS Intermediate flanges

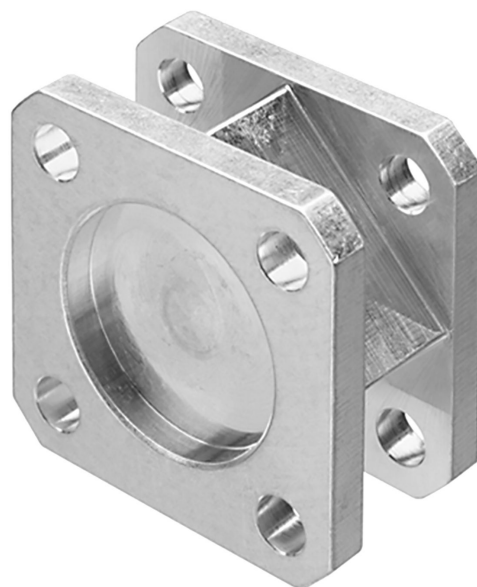

## Technical data

Industry

Industrial

Version

for multi-position cylinders

Piston diameter

40 mm

## Material

Housing material

Aluminum

Part No.

1827020248

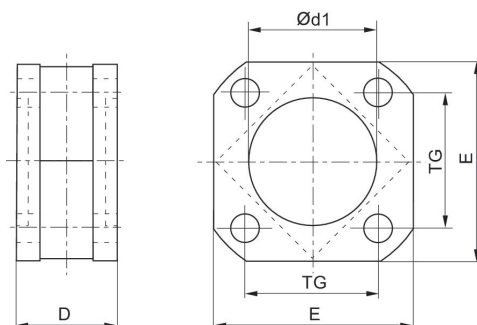

Piston Ø	Part No.	D	Ø d1 N7	E	TG
32	1827020247	27	30	47	32.5
40	1827020248	27	35	53	38
50	1827020249	32	40	65	46.5
63	1827020250	28	45	75	56.5
80	1827020251	38	45	95	72
100	1827020252	38	55	115	89
125	1827020253	44	60	140	110