

Intermediate flange JP2, Series CM1

1827020271

General series information
AVENTICS Intermediate flanges



Technical data

Industry	Industrial
Version	for multi-position cylinders
For series	CCI KPZ
Piston diameter	50 mm

Material

Housing material	Aluminum
Part No.	1827020271

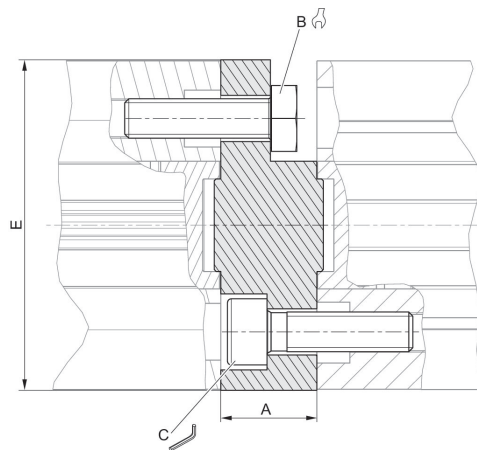

Piston Ø	Part No.	For series	A	B	C	Md [Nm] 1)	E
16	1827020290	CCI, KPZ	12.5	7	–	2.5	28.4
20	1827020267	CCI, KPZ	12.5	8	–	4	35
25	1827020268	CCI, KPZ	13	8	4	4	40
32	1827020269	CCI, KPZ	14.5	10	5	4	50
40	1827020270	CCI, KPZ	14.5	10	5	4	57.1
50	1827020271	CCI, KPZ	14.5	13	6	8	67.4
63	1827020272	CCI, KPZ	14.5	13	6	8	80
80	R412024535	KPZ	16.5	16	8	16	95
80	1827020273	CCI	16.5	16	–	16	98.4
100	R412024536	CCI	19.5	16	8	16	115
100	1827020274	KPZ	19.5	16	–	16	120

1) torque