

Flange mounting MF1, MF2, Series CM1

1827001277

Flange
mountings

2023-11-14

AVENTICS Flange mountings

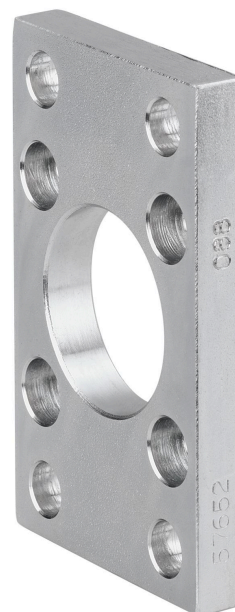

Technical data

Industry

Industrial

Standardization

ISO 15552

Piston diameter

32 mm

Material

Housing material

Steel, chrome-plated

Surface housing

galvanized

Screws material

Steel, chrome-plated

Surface screws

galvanized

Part No.

1827001277

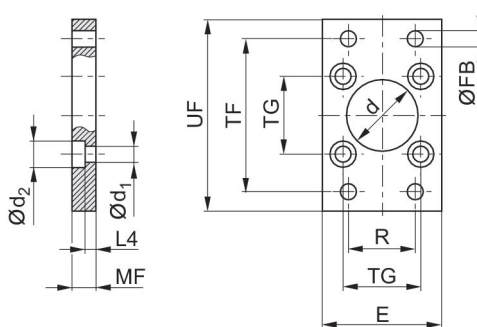

Flange mounting MF1, MF2, Series CM1

1827001277

Flange
mountings

2023-11-14

Piston Ø	Part No.	Ød H11	Ød1	Ød2	E max.	ØFB	L4	MF	R
32	1827001277	30	6.6	11	50	7	4.5	10	32
40	1827001278	35	6.6	11	55	9	4.5	10	36
50	1827001279	40	9	15	65	9	6	12	45
63	1827001499	45	9	15	75	9	6	12	50
80	1827001281	45	11	18	100	12	9	16	63
100	1827001282	55	11	18	120	14	9	16	75
125	1827004861	60	14	20	140	16	10.5	20	90
160	1827001460	65	18	26	180	18	9.5	20	115
200	1827001461	75	18	26	220	22	12.5	25	135
250	1827001462	90	22	33	280	26	10.5	25	165
320	5239016012	110	26	40	350	33	15	30	200

Piston Ø	TF	TG	UF
32	64	32,5 ±0,2	80
40	72	38 ±0,2	90
50	90	46,5 ±0,2	110
63	100	56,5 ±0,2	125
80	126	72 ±0,2	154
100	150	89 ±0,2	186
125	180	110 ±0,3	220
160	230	140 ±0,3	275
200	270	175 ±0,3	312
250	330	220 ±0,3	380
320	270	270 ±0,3	400