

Clevis mounting MP2, Series CM1

3682908590

Clevis
mounting

2024-03-26

AVENTICS Clevis mountings



Technical data

Industry

Industrial

Version

Corrosion-resistant version
Suitable for robust mechanical engineering
applications

Standardization

ISO 15552

Piston diameter

80 mm

Weight

0.574 kg

Material

Material

Aluminum

Surface

forged and anodized

Screws material

Stainless Steel

Bearing material

Plastic

Part No.

3682908590

Clevis mounting MP2, Series CM1

3682908590

Clevis
mounting

2024-03-26

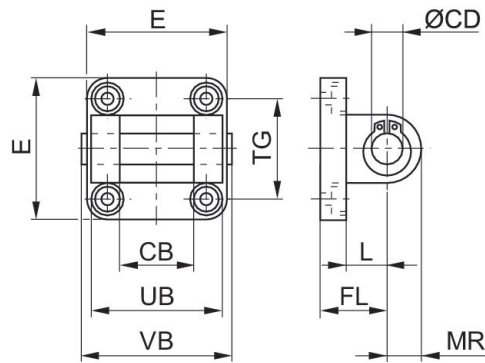

Cylinders Ø	Part No.	CB H14	Ø CD H9	E max.	FL	L min.	MR	UB h14	VB
32	3682903590	26	10	47	22 ±0,2	12	10	45	50
40	3682904590	28	12	54	25 ±0,2	15	12	52	57
50	3682905590	32	12	65	27 ±0,2	15	12	60	65
63	3682906590	40	16	75	32 ±0,2	20	15	70	76
80	3682908590	50	16	94	36 ±0,2	20	17	90	96
100	3682910590	60	20	112	41 ±0,2	25	21	110	117
125	R412025571	70	25	138	50	30	26	130	140

Cylinders Ø	TG
32	32,5 ±0,2
40	38,0 ±0,2
50	46,5 ±0,2
63	56,5 ±0,2
80	72,0 ±0,2
100	89,0 ±0,2
125	110,0 ±0,3