

## AVENTICS Rear eyes



### Technical data

Industry	Industrial
Version	With ball joint and foot
Standardization	ISO 15552
Piston diameter	50 mm
Swivel bearing Ø	16 mm
Weight	0.2 kg

### Material

Housing material	Aluminum (forged)
Screws material	Galvanized Steel
Bearing material	Stainless Steel
Bearing material, inner ring	Stainless Steel
Bearing material, outer ring	Brass with PTFE coating
Part No.	1827001621

# Rear eye MP6, Series CM1

1827001621

Rear eye

2023-10-25

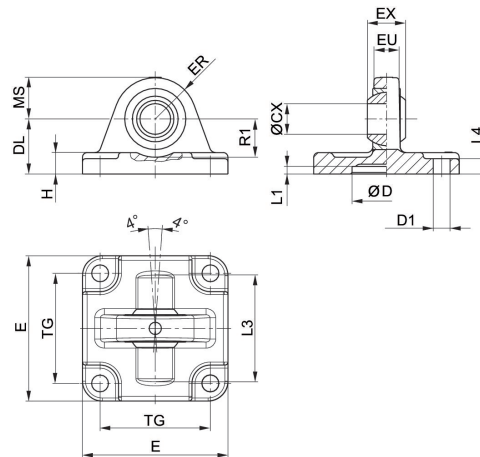

Scope of delivery: clevis incl. mounting screws

Piston Ø	Part No.	ØCX H7	ØD H11	ØD1 H13	DL ±0,2	E	EX -0,1	ER	EU
32	1827001619	10	30	6.6	22	47	14	15	10.5
40	1827001620	12	35	6.6	25	53	16	18	12
50	1827001621	16	40	9	27	65	21	20	15
63	1827020087	16	45	9	32	75	21	23	15
80	1827001623	20	45	11	36	95	25	27	18
100	1827001624	20	55	11	41	115	25	30	18
125	1827001625	30	60	14	50	140	37	40	25

Piston Ø	H	L1 min.	L3	L4	MS -0,5	R1 min.	TG
32	9	4.5	36	5.5	15	12	32,5 ±0,2
40	9	4.5	42	5.5	18	15	38 ±0,2
50	10.5	4.5	48	6.5	21	19	46,5 ±0,2
63	10.5	4.5	55	6.5	23	21	56,5 ±0,2
80	14	4.5	70	10	27	24	72 ±0,2
100	15	4.5	80	10	30	25	89 ±0,2
125	16	7	100	10	40	33	110 ±0,3