

AVENTICS Rear eyes



Technical data

Industry	Industrial
Version	With ball joint and foot
Standardization	ISO 15552
Piston diameter	100 mm
Swivel bearing Ø	20 mm
Weight	0.8 kg

Material

Housing material	Aluminum (forged)
Screws material	Galvanized Steel
Bearing material	Stainless Steel
Bearing material, inner ring	Stainless Steel
Bearing material, outer ring	Brass with PTFE coating
Part No.	1827001624

Rear eye MP6, Series CM1

1827001624

Rear eye

2023-10-25

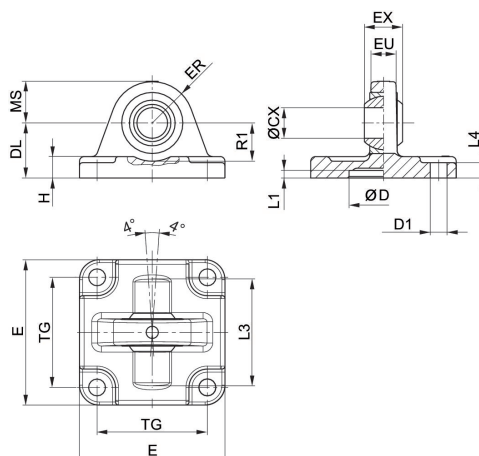

Scope of delivery: clevis incl. mounting screws

Piston Ø	Part No.	ØCX H7	ØD H11	ØD1 H13	DL ±0,2	E	EX -0,1	ER	EU
32	1827001619	10	30	6.6	22	47	14	15	10.5
40	1827001620	12	35	6.6	25	53	16	18	12
50	1827001621	16	40	9	27	65	21	20	15
63	1827020087	16	45	9	32	75	21	23	15
80	1827001623	20	45	11	36	95	25	27	18
100	1827001624	20	55	11	41	115	25	30	18
125	1827001625	30	60	14	50	140	37	40	25

Piston Ø	H	L1 min.	L3	L4	MS -0,5	R1 min.	TG
32	9	4.5	36	5.5	15	12	32,5 ±0,2
40	9	4.5	42	5.5	18	15	38 ±0,2
50	10.5	4.5	48	6.5	21	19	46,5 ±0,2
63	10.5	4.5	55	6.5	23	21	56,5 ±0,2
80	14	4.5	70	10	27	24	72 ±0,2
100	15	4.5	80	10	30	25	89 ±0,2
125	16	7	100	10	40	33	110 ±0,3