

AVENTICS Rear eyes



Technical data

Industry	Industrial
Version	With ball joint and foot
Standardization	ISO 15552
Piston diameter	200 mm
Swivel bearing Ø	35 mm
Weight	8.5 kg

Material

Housing material	Nodular graphite iron
Surface housing	galvanized
Screws material	Galvanized Steel
Bearing material, inner ring	Stainless Steel
Bearing material, outer ring	Brass with PTFE coating
Part No.	1827001627

Rear eye MP6, Series CM1

1827001627

Rear eye

2023-10-25

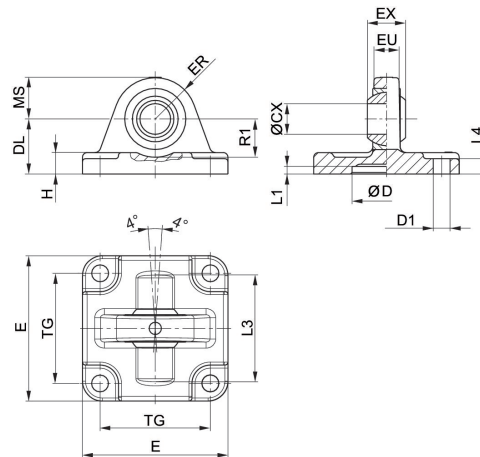

Scope of delivery: clevis incl. mounting screws

Piston Ø	Part No.	ØCX H7	ØD H11	ØD1 H13	DL ±0,2	E	EX -0,1	ER	EU
160	1827001626	35	65	18	55	176	43	44	30
200	1827001627	35	75	18	60	216	43	47	30
250	1827001628	40	90	22	70	275	49	53	35
320	5239013452	50	110	26	80	340	60	63	45

Piston Ø	H	L1 min.	L3	L4	MS -0,5	R1 min.	TG
160	17	7	130	10	44	39	140 ±0,3
200	19.5	7	130	11	47	41	175 ±0,3
250	22	11	-	11	53	45	220 ±0,3
320	27	11	180	15	63	55	270 ±0,3