

AVENTICS Rear eyes

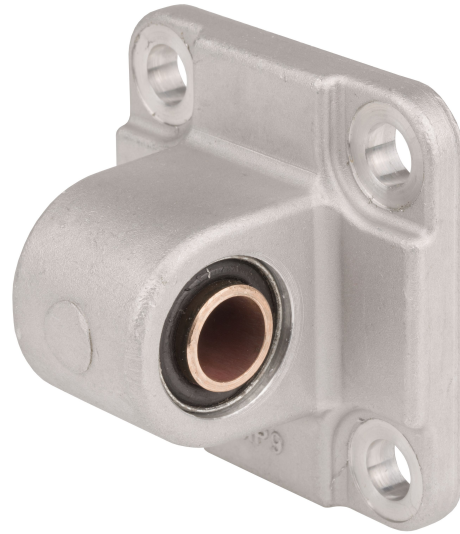

Technical data

Industry	Industrial
Version	With rubber bushing
Standardization	ISO 15552
Piston diameter	63 mm
Swivel bearing Ø	16 mm
Weight	0.411 kg

Material

Housing material	Aluminum
Surface housing	forged
Bearing material	Bronze
Fig.	Fig. 1
Part No.	3683206000

Rear eye MP9, Series CM1

3683206000

Rear eye

2023-10-25

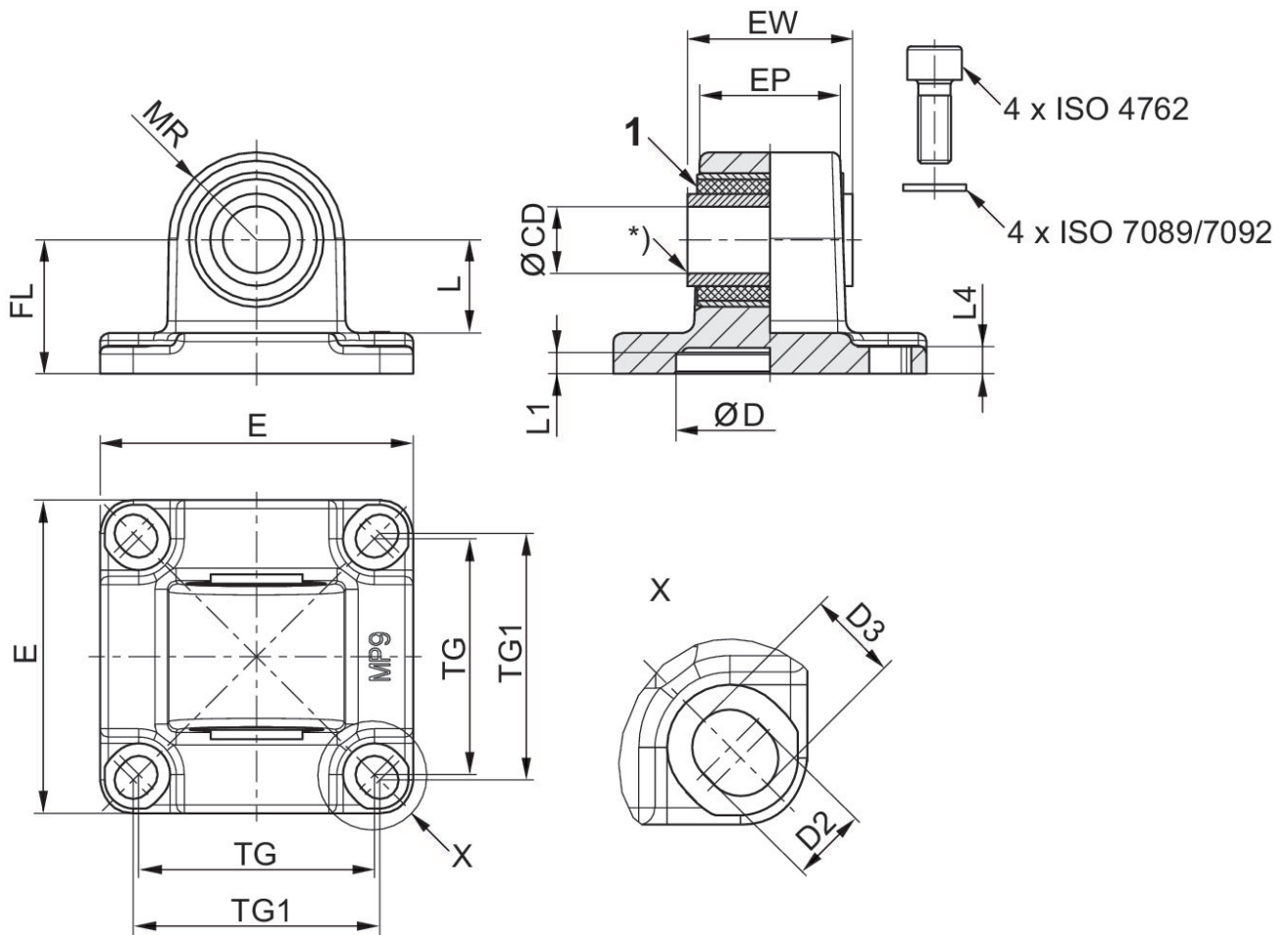

1) Rubber bushing

Piston Ø	Part No.	CD H11	CD H9	E	EW	EP	TG	TG1 ±0,2	FL ±0,2
25	3683202000	10	-	40	17.5	14,5	26	27	20
40	3683204000	-	12	53	27	23,5	38	40	25
63	3683206000	-	16	75	39.5	33.5	56.5	59	32
100	3683210000	-	20	114	59.5	54	89	90	41

Piston Ø	L 1)	MR	L1	L4	D H11	D2 -0,2	D3 -0,2
25	14.8	12,5	3	3	18	5,5	6,2
40	16.3	15	5	5.5	35	6.6	8
63	22.3	21	5	6.5	45	-	-
100	25.8	25	5	10	55	11	11.7