

## AVENTICS Rear eyes

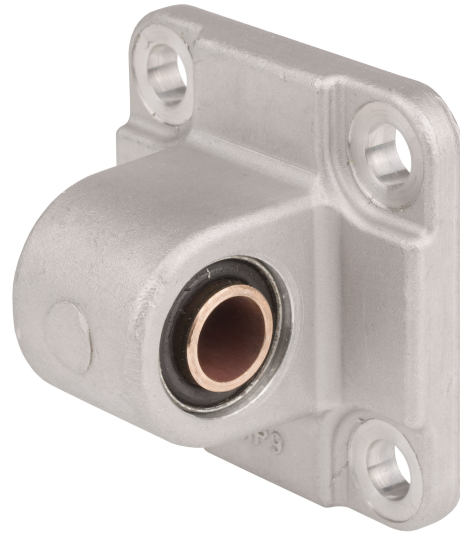

### Technical data

Industry	Industrial
Version	With rubber bushing
Piston diameter	80 mm
Swivel bearing Ø	16 mm
Weight	0.619 kg

### Material

Housing material	Aluminum
Surface housing	forged
Bearing material	Bronze
Fig.	Fig. 2
Part No.	3663208000

# Rear eye MP9, Series CM1

3663208000

Rear eye

2023-10-25

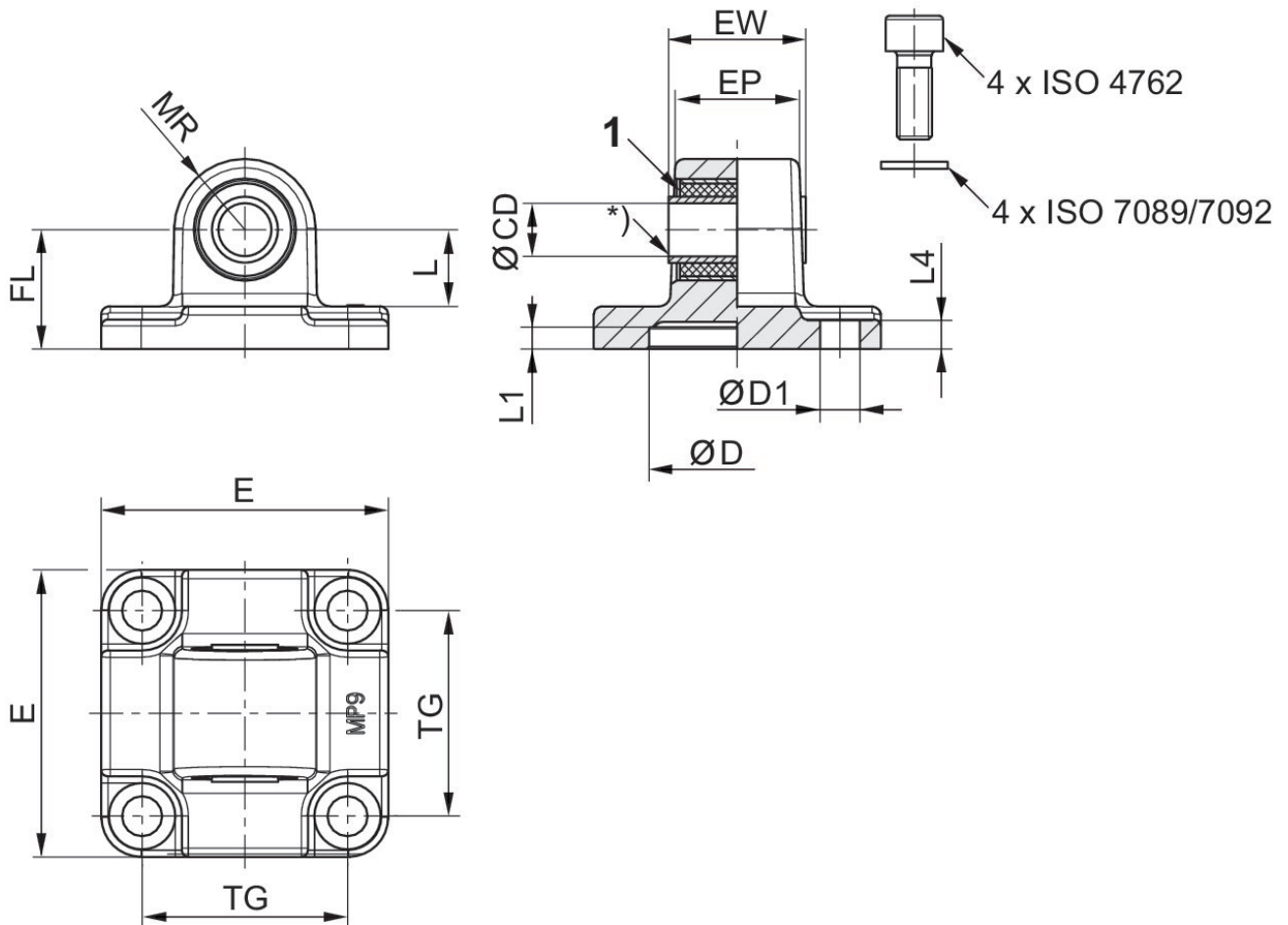

1) Rubber bushing

Piston Ø	Part No.	CD H11	CD H9	E	EW	EP	TG	TG1 ±0,2	FL ±0,2
32	3683203000	10	-	46	25.5	18,9	32.5	-	22
50	3683205000	-	12	65	31	28	46.5	-	27
50	3663205000	-	12	63	31		46		28
80	3663208000	-	16	95	49.5		73		38
80	3683208000	-	16	94.5	49.5	43	72	-	36
125	R412015973	-	25	138	69.5	60	110	-	50

Piston Ø	L 1)	MR	L1	L4	D H11	D1 H13
32	13.8	12.5	5	5.5	30	6.6
50	17.3	16	5	6.5	40	9
50	15.5	18				
80	20.5	24				
80	21.8	22	5	10	45	11
125	33.8	34	7.5	10	60	13.5