

Round nut with set pin hole inside MR3, series CM1

8915307604

Nuts for
cylinder
mounting

2023-11-28

AVENTICS Nuts for cylinder mounting



Technical data

Industry	Industrial
Version	for cylinder mounting
For series	RPC
Piston diameter	40 mm
Thread size	M38x1,5
Weight	0.06 kg

Material

Material	Steel, chrome-plated
Surface	galvanized
Part No.	8915307604

Round nut with set pin hole inside MR3, series CM1

8915307604

Nuts for
cylinder
mounting

2023-11-28

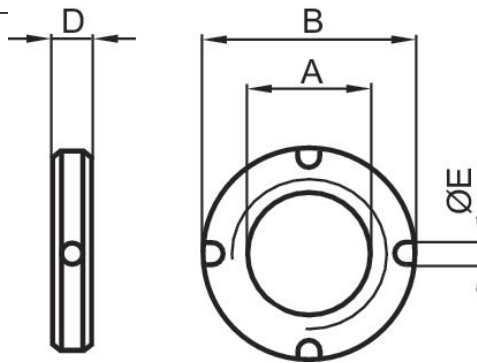

Piston Ø	Part No.	A	Ø B	D	E
32	8915308704	M30x1,5	38	8	4
40	8915307604	M38x1,5	50	10	5
50, 63	8915309004	M45x1,5	55	10	5