

Foot mounting MS1, Series CM1

R412027804

Foot
mountings

2024-08-29

AVENTICS Foot mountings



Technical data

Industry

Industrial

Version

Version: ISO-type

For series

RPC

Piston diameter

63 mm

Material

Material

Galvanized Steel

Part No.

R412027804

Dimensions

Foot mounting MS1, Series CM1

R412027804

Foot
mountings

2024-08-29

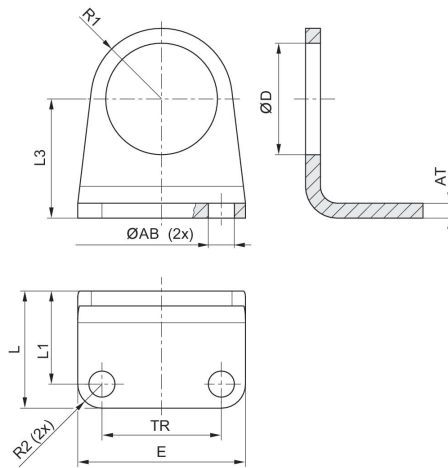

Piston Ø	Part No.	Ø AB H13	AT	E	TR	Ø D	L	L1	L2
32	R412027801	7	4	45	32	30	31.5	25	32
40	R412027802	9	4	52	36	38	38	24/30 **contains elongated hole	36
50	R412027803	9	5	65	45	45	40	30	45
63	R412027804	9	5	70	50	45	40	30	50

Piston Ø	R1	R2
32	19	6.5
40	24	8
50	28	10
63	35	10

**contains elongated hole