

# Rod clevis AP2, Series CM2

1827001472

Rod  
clevises

2023-10-05

## AVENTICS Rod clevises

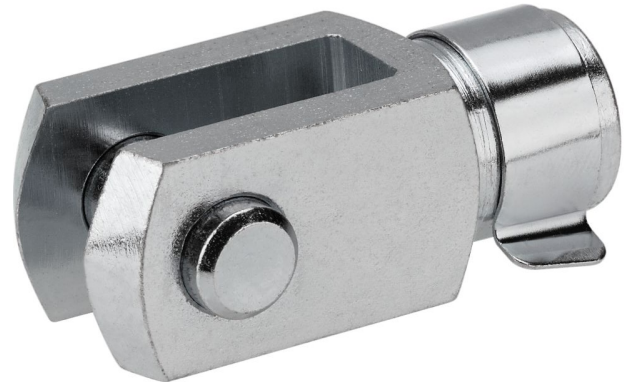

### Technical data

Industry

Industrial

For series

to mount on cylinder PRA, TRB, CCI, MNI, ICM, KPZ, KHZ, 167, CVI, RPC, RDC, ITS

For series

ITS

Thread size

M42x2

Weight

6.6 kg

### Material

Housing material

Steel, chrome-plated

Surface housing

galvanized

Part No.

1827001472

# Rod clevis AP2, Series CM2

1827001472

Rod  
clevises

2023-10-05

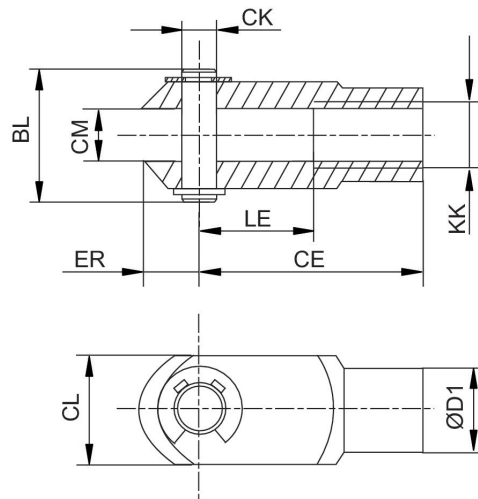

KK	Part No.	BL	CE	ØCK e11	CL	CM	ØD1	ER	LE
M27x2	1827001493	68	110	30	55	30	48	38	54
M36x2	1827001471	80	144	35	70	35	60	57	72
M42x2	1827001472	98	168	40	85	40	70	64	84