

Rod clevis AP2, Series CM2

2990600505

Rod
clevises

2023-10-05

AVENTICS Rod clevises



Technical data

Industry

Industrial

For series

with split pin
to mount on cylinder SSI, ICS-D2

For series

SSI
ICS-D2

Thread size

M16x1,5

Weight

0.41 kg

Material

Housing material

Stainless Steel

Surface housing

acid-proof

Part No.

2990600505

Rod clevis AP2, Series CM2

2990600505

Rod
clevises

2023-10-05

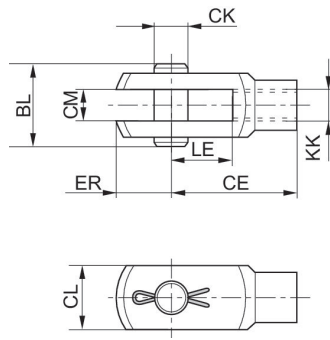

KK	Part No.	CE	CK e8	CL	CM B12	ER	BL	LE
M10x1,25	2990600503	40	10	20	10	12	26	20
M12x1,25	2990600504	48	12	24	12	14	31	24
M16x1,5	2990600505	64	16	32	16	19	39	32
M20x1,5	2990600508	80	20	40	20	20	49	40