

- Coil widths 15, 22 and 30 mm
- Electr. control: M8, form A, form B, form BI, form C
- ATEX
- Operational voltages 12, 24, 48, 110, 220 VDC or 24,110,230 VAC

AVENTICS Series CO1 Coils

The AVENTICS Series CO1 is a complete range of electrical solenoid coils with or without cable used in AVENTICS pneumatic valves Series.



Technical data

Industry	Industrial
Type	Cable with valve plug connector
Coil width	30 mm
ATEX ID	ATEX II 2G Ex mb IIC T4 Gb II 2D Ex mb tb IIIC T130°C Db IP65
Min. ambient temperature	-20 °C
Max. ambient temperature	50 °C
Protection class according to EN 60529	IP65
Cable length	3 m
Duty cycle ED	100 %
Compatibility index	14
Operational voltage AC at 50 Hz	24 V
Operational voltage AC at 60 Hz	24 V
Voltage tolerance AC 50 Hz	-10 % / +10 %
Holding power AC 50 Hz	2.9 VA
Switch-on power AC 50 Hz	3 VA
Weight	0.38 kg

Coil, Series CO1, with cable, ATEX

1827414301

Series CO1

2024-10-08

Material

Part No.

1827414301

Dimensions

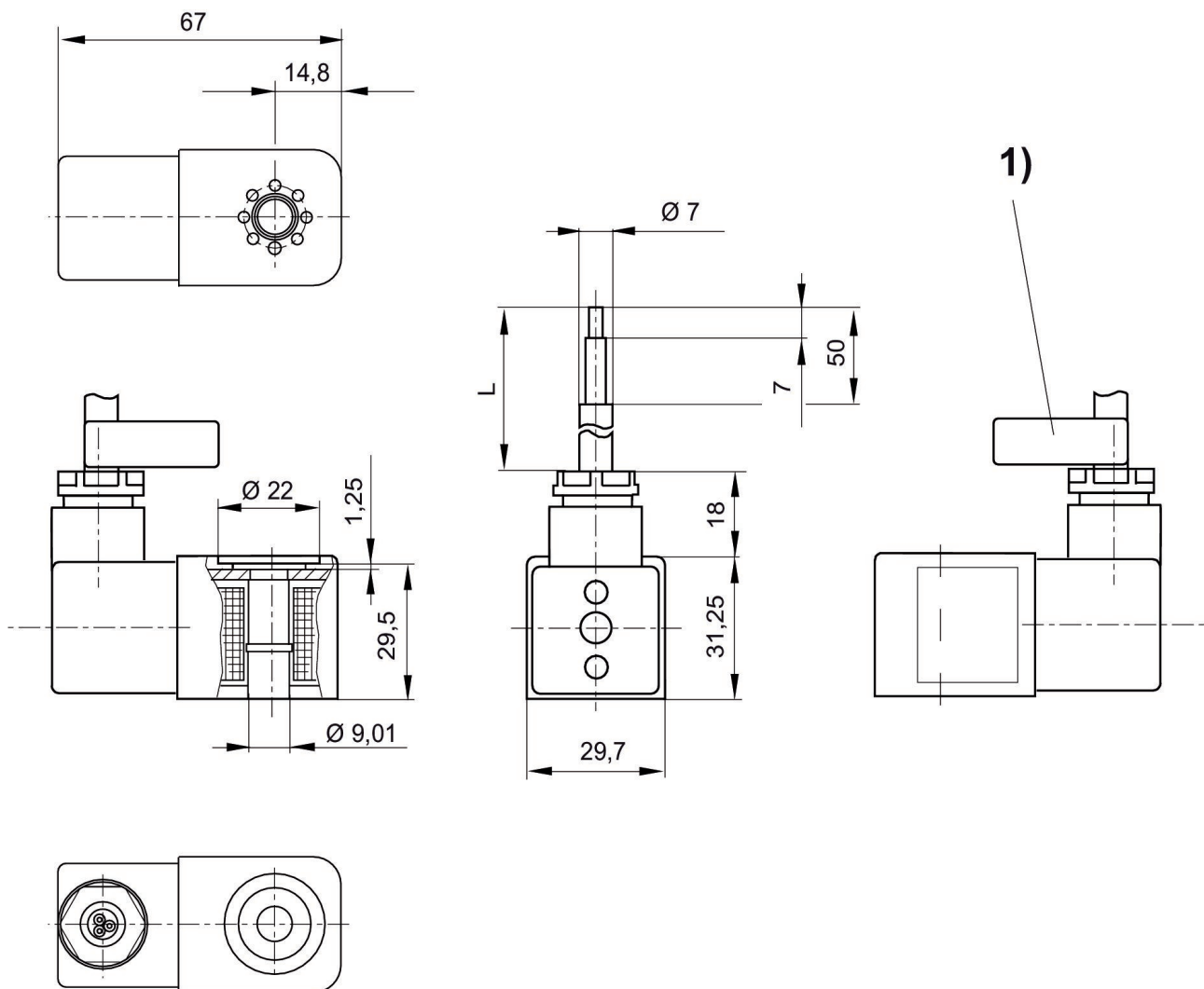

L = cable length

1) Cable ID band with serial number