

AVENTICS Series CON-MP Multipole plugs with cable

The AVENTICS Series CON-MP-with cable offers cables with a multipole plug like D-SUB with various numbers of pins and different length, optimized for our focused valve system Series like AV Also C/2 connectors for Valve systems of Series CL03 are available.



Technical data

Industry	Industrial
Type	Multipole
Cable	with cable
Operational voltage	24 V DC
Max. operating voltage AC	24 V DC
Electrical connection 1, type	Socket
Electrical connection 1, thread size	C/2
Electrical connection 1, number of poles	48-pin
Cable exit 1	angled
Cable exit angle	45°
Electrical connection 2, type	open cable ends
Electrical connection 2, number of poles	48-pin
Number of wires	40
Shielding	unshielded
Cable length	5 m
Protection class	IP69K
Min. ambient temperature	0 °C
Max. ambient temperature	50 °C
Max. current	3 A

Multipole plug, series CON-MP

2024-04-02

0493871106

Wire cross-section	0.34 mm ²
Cable-Ø	13.5 mm
Weight	1.483 kg

Material

Housing material	Polyamide
Material cable sheath	Polyvinyl chloride
Part No.	0493871106

Technical information

The specified protection class is only valid in assembled and tested state.
max. 16 valves

Dimensions

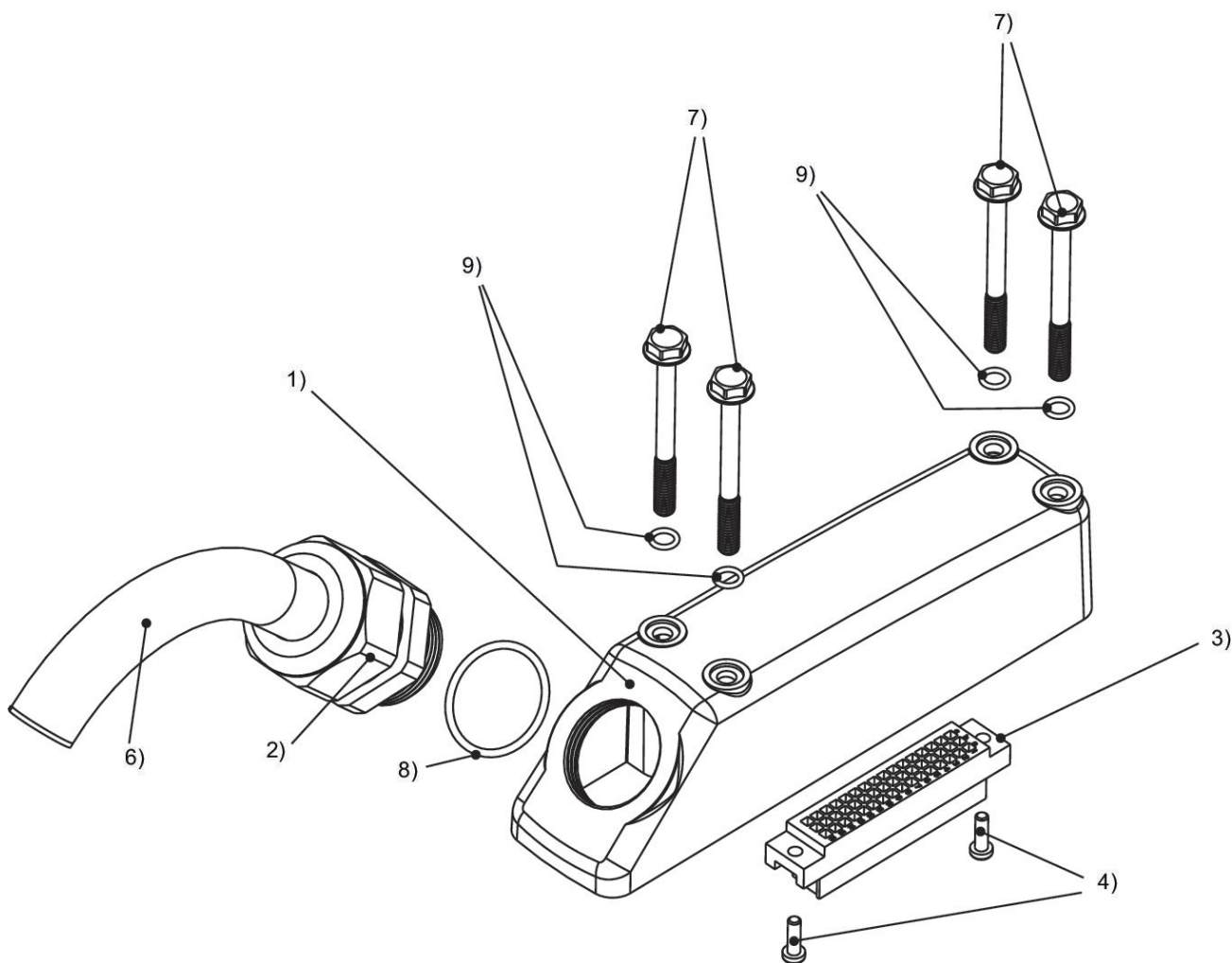

1) housing 2) cable gland 3) connector housing size C/2 4) screw 5) seal 6) cable 7) screw 8) seal 9) seal

PIN assignment and cable colors

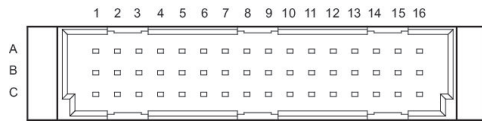

PIN assignment and cable colors, 48-pin

Pin Color	A	B	C
1	not assigned	white	brown
2	red/blue	green	yellow
3	white/blue	gray	pink
4	brown/blue	red	black
5	green/blue	violet	gray/pink
6	yellow/blue	white/green	brown/green
7	gray/blue	white/yellow	yellow/brown
8	pink/blue	white/gray	gray/brown
9	blue	white/pink	pink/brown
10	not assigned	white/red	brown/red
11	not assigned	white/black	brown/black
12	not assigned	gray/green	yellow/gray
13	not assigned	pink/green	yellow/pink
14	not assigned	green/red	yellow/red
15	not assigned	green/black	yellow/black
16	not assigned	gray/red	pink/red