

AVENTICS Series CON-MP Multipole plugs with cable

The AVENTICS Series CON-MP-with cable offers cables with a multipole plug like D-SUB with various numbers of pins and different length, optimized for our focused valve system Series like AV Also C/2 connectors for Valve systems of Series CL03 are available.



Technical data

Industry	Industrial
Type	Multipole
Cable	with cable
Operational voltage	24 V DC
Max. operating voltage AC	24 V DC
Electrical connection 1, type	Socket
Electrical connection 1, thread size	D-Sub
Electrical connection 1, number of poles	25-pin
Cable exit 1	straight
Cable exit angle	180°
Electrical connection 2, type	open cable ends
Electrical connection 2, number of poles	25-pin
Number of wires	25
Shielding	unshielded
Cable length	5 m
suitable for dynamic laying	suitable for dynamic laying
Certificates	UL (Underwriters Laboratories)
Protection class	IP65
Min. ambient temperature	-5 °C

Multipole plug, series CON-MP

2024-04-02

R412011253

Max. ambient temperature	50 °C
Max. current	3 A
Wire cross-section	0.34 mm ²
Cable-Ø	12 mm
Weight	1.28 kg

Material

Housing material	Polyamide
Material cable sheath	Polyurethane
Part No.	R412011253

Technical information

The specified protection class is only valid in assembled and tested state.

Note for use with VS LP04: The plug can only be used in the LP04 versions with a side electrical connection.

The min. control pressure must be adhered to, since otherwise faulty switching and valve failure may result!

The pressure dew point must be at least 15 °C less than ambient and medium temperature and may not exceed 3 °C.

The oil content of compressed air must remain constant during the life cycle.

Use only the approved oils from AVENTICS. Further information can be found in the “Technical information” document (available in <https://www.emerson.com/en-us/support>).

Fig. 2

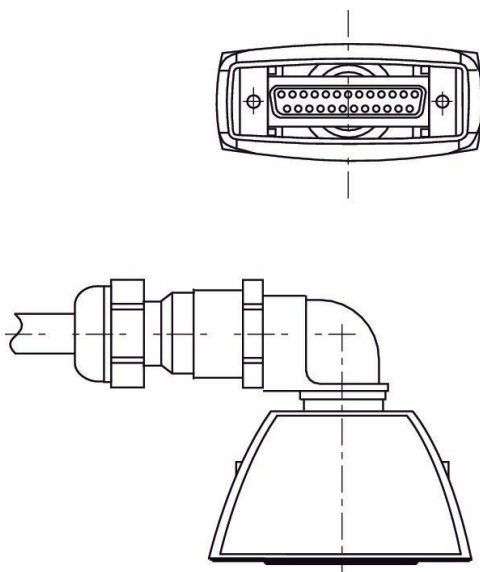
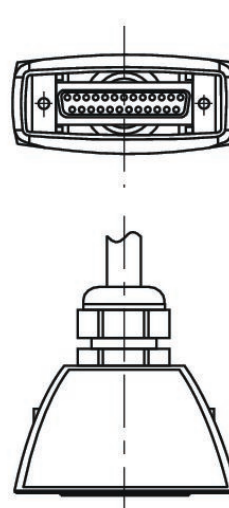

Fig. 1



Multipole plug, series CON-MP

2024-04-02

R412011253

PIN assignment and cable colors
cable identification as per DIN 47100

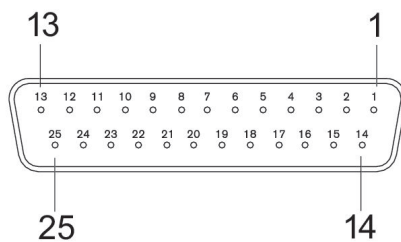

Socket

D-Sub socket, 25 pin

Pin	Color
1	white
2	brown
3	green
4	yellow
5	gray
6	pink
7	blue
8	red
9	black
10	violet
11	gray/pink
12	red/blue
13	white/green
14	brown/green
15	white/yellow
16	yellow/brown
17	white/gray
18	gray/brown
19	white/pink
20	pink/brown
21	white/blue
22	brown/blue
23	white/red
24	brown/red
25	white/black