

Round plug connector, Series CON-RD

1834484247

General series information

AVENTICS Series CON-RD Round plug connectors with cable

- The AVENTICS Series CON-RD-with cable offers cables with round plug connectors for various types like M8x1, M12x1 or 7/8-16UNC and different cable length, optimized for our focused valves with M8x1 or M12x1 connection and electronic systems like AES and G3.

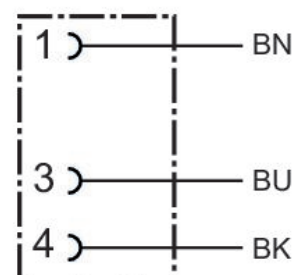

Technical data

Industry

Industrial

Type

Round plug connectors

Cable

with cable

Operational voltage

48 V AC/DC

Operating voltage AC max.

48 V DC

Operating voltage DC, max.

48 V AC

Electrical connection 1, type

Socket

Electrical connection 1, thread size

M8x1

Electrical connection 1, number of poles

3-pin

Electrical connection 1, coding

A-coded

Cable exit 1

straight

Cable exit angle

180°

Electrical connection 2, type	open cable ends
Number of wires	3
Shielding	unshielded
Cable length	10 m
Protection class	IP67
Min. ambient temperature	-25 °C
Max. ambient temperature	85 °C
Max. current	4 A
Wire cross-section	0.24 mm ²
Cable-Ø	4.5 mm
Weight	0.277 kg

Material

Housing material	Polyurethane
Material cable sheath	Polyurethane
Part No.	1834484247

Technical information

The specified protection class is only valid in assembled and tested state.

Dimensions

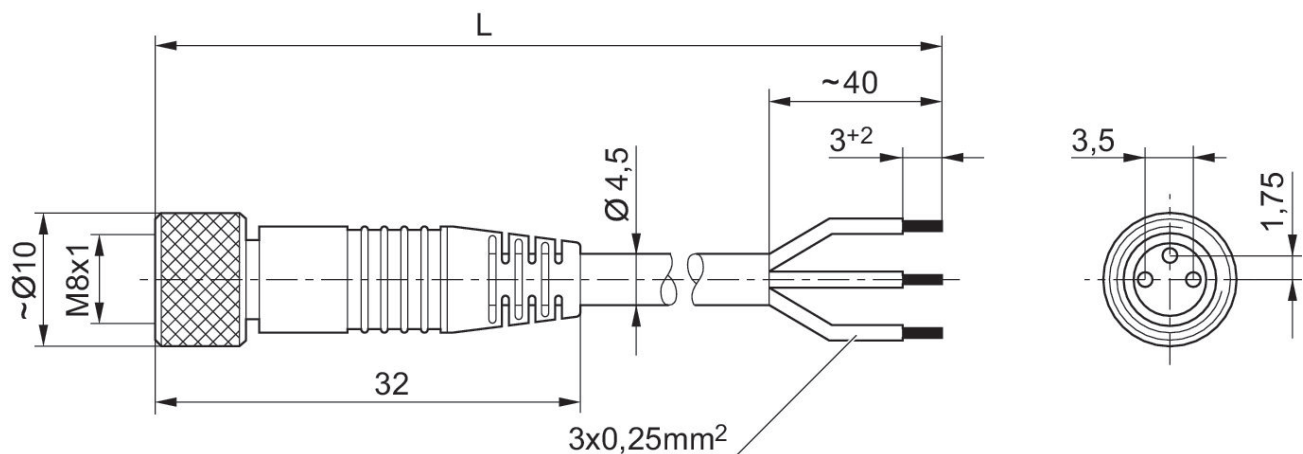

L = length

Pin assignment, socket

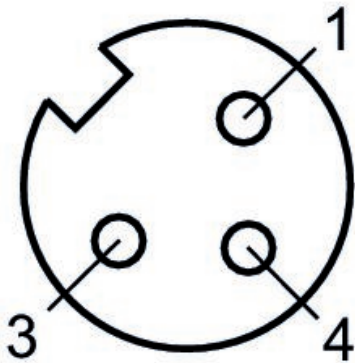

(1) BN=brown (3) BU=blue (4) BK=black