

Round plug connector, Series CON-RD

R412023861

General series information

AVENTICS Series CON-RD Round plug connectors with cable

- The AVENTICS Series CON-RD-with cable offers cables with round plug connectors for various types like M8x1, M12x1 or 7/8-16UNC and different cable length, optimized for our focused valves with M8x1 or M12x1 connection and electronic systems like AES and G3.

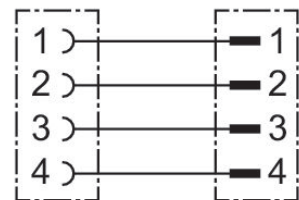
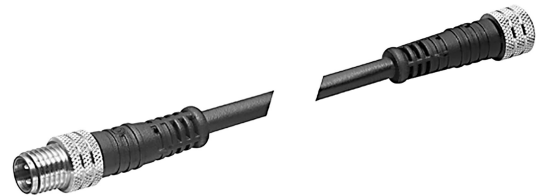

Technical data

Industry	Industrial
Type	Round plug connectors
Cable	with cable
Operational voltage	30 V AC/DC
Operating voltage AC max.	30 V DC
Operating voltage DC, max.	30 V AC
Electrical connection 1, type	Socket
Electrical connection 1, thread size	M8x1
Electrical connection 1, number of poles	4-pin
Electrical connection 1, coding	A-coded
Cable exit 1	straight
Cable exit angle	180°
Electrical connection 2, type	Plug
Electrical connection 2, thread size	M8x1

Electrical connection 2, number of poles	4-pin
Electrical connection 2, coding	A-coded
Cable exit 2	straight
Cable exit angle	180°
Number of wires	4
Shielding	unshielded
Cable length	1 m
suitable for dynamic laying	suitable for dynamic laying
Bending radius min.	44 mm
Protection class	IP68
Min. ambient temperature	-25 °C
Max. ambient temperature	80 °C
Max. current	4 A
Wire cross-section	0.25 mm ²
Cable-Ø	4.4 mm
Mounting screw tightening torque	0.6 Nm
Delivery unit	1 piece
Weight	0.05 kg

Material

Housing material	Polyurethane
Material cable sheath	Polyurethane
Part No.	R412023861

Dimensions

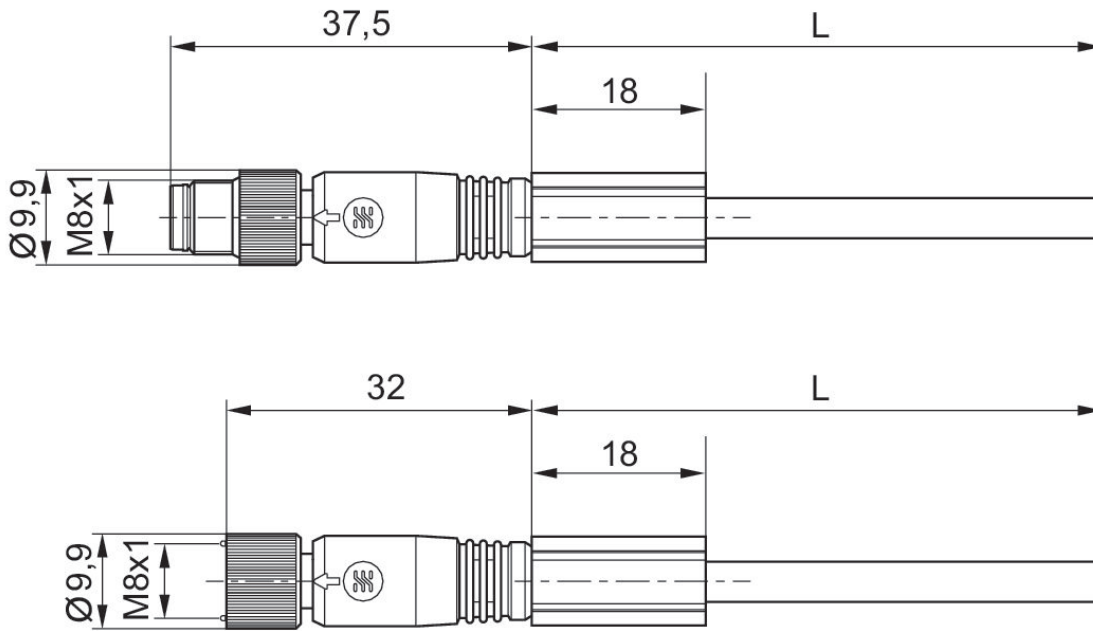

L = length

Plug pin assignment

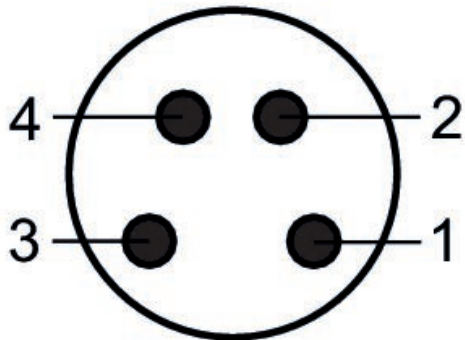

(1) BN=brown (2) WH=white (3) BU=blue (4) BK=black

Pin assignment, socket

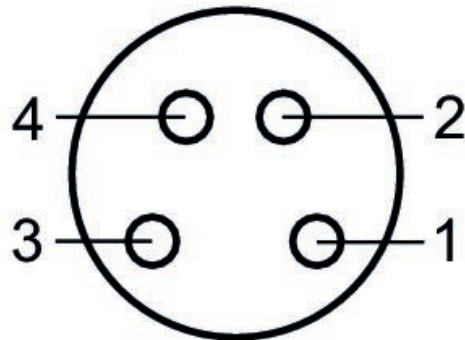

(1) BN=brown (2) WH=white (3) BU=blue (4) BK=black