

# Valve plug connector, series CON-VP

1834484210

Valve plug connector with cable, series CON-VP

- Valve plug connector with connected cable
- Form A EN 175301-803
- Form B ISO 6952 and B industry
- Form C ISO 15217 and C industry
- With/without protective circuit/LED

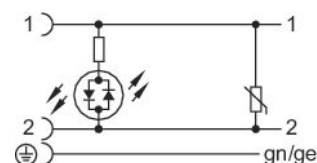
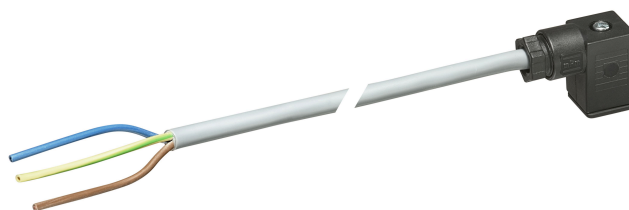

## Technical data

Industry  
Industrial

Type  
Valve plugs

Cable  
with cable

Operational voltage  
230 V AC/DC

Operating voltage AC max.  
230 V DC

Operating voltage DC, max.  
230 V AC

Electrical connection 1, type  
Socket

Electrical connection 1, thread size  
form C

Electrical connection 1, number of poles  
2+E

Cable exit  
angled

Cable exit angle  
90°

Electrical connection 2, type  
open cable ends

Electrical connection 2, number of poles  
3-pin

Contact assignment  
2+E

Number of wires  
3

Shielding  
unshielded

Cable length  
5 m

Protection class  
IP67

Protective circuit

Varistor

Min. ambient temperature

-20 °C

Max. ambient temperature

80 °C

Max. current

6 A

with LED

Yellow

Wire cross-section

0.75 mm<sup>2</sup>

Cable-Ø

5.9 mm

Mounting screw tightening torque

0.4 Nm

Weight

0.297 kg

## Material

Seal material

caoutchouc/butadiene caoutchouc

Material cable sheath

Polyvinyl chloride

Part No.

1834484210

## Technical information

The specified protection class is only valid in assembled and tested state.

## Fig. 2

Dimensions in mm

180° female insert

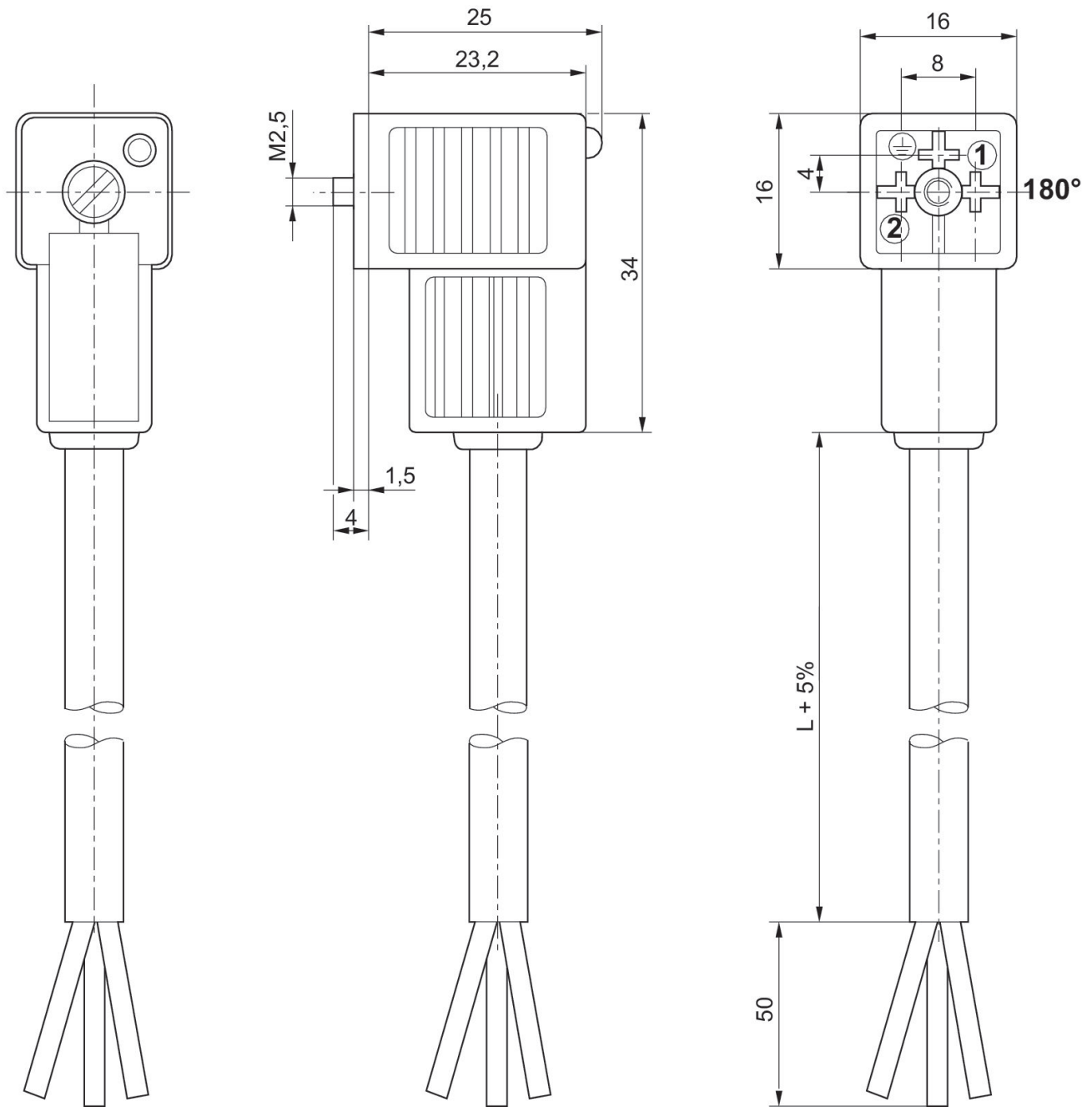

Fig. 1  
Dimensions in mm

0° female insert

