

Series H-Controlair®



Technical data

Industry

Industrial

Type

Version H-1

OUT port – delivers increasing pressure in direct proportion to pedal depression.

Type

Poppet valve

Actuating element

Pedal

Compressed air connection input

1/4 NPT

Compressed air connection type input

Internal thread

Compressed air connection output

1/4 NPT

Compressed air connection type output

Internal thread

Min. working pressure

0.1 bar

Max. working pressure

14 bar

Min. regulation range

0.1 bar

Max. regulation range

4.5 bar

Min. ambient temperature

-40 °C

Max. ambient temperature

70 °C

Min. medium temperature

-40 °C

Max. medium temperature

70 °C

Medium

Compressed air

Nominal flow Qn

900 l/min

Series H-Controlair®

R431002613

H-
Controlair®

2024-04-02

Hysteresis	< 0,1 bar
Min. actuating force	90 N
Weight	2.3 kg
Housing material	Die-cast aluminum
Seal material	Acrylonitrile butadiene rubber
Material pedal	Die-cast aluminum
Part No.	R431002613

Technical information

IN port = pressure supply

OUT port – delivers increasing pressure in direct proportion to pedal depression.

The min. control pressure must be adhered to, since otherwise faulty switching and valve failure may result!

The pressure dew point must be at least 15 °C less than ambient and medium temperature and may not exceed 3 °C.

The oil content of compressed air must remain constant during the life cycle.

Use only the approved oils from AVENTICS. Further information can be found in the “Technical information” document (available in <https://www.emerson.com/en-us/support>).

Series H-Controlair®

R431002613

H-
Controlair®

2024-04-02

Dimensions in inches

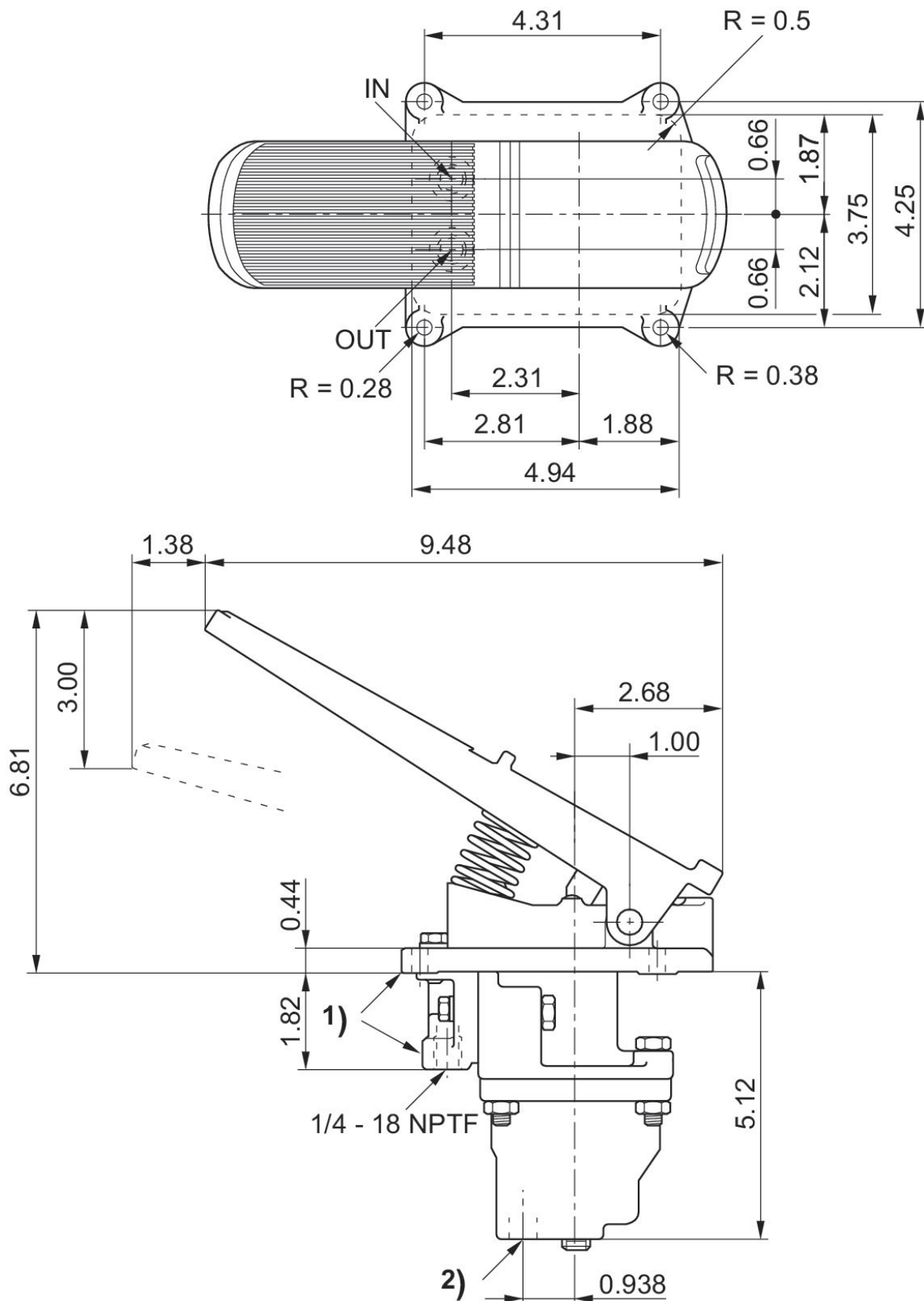

- 1) Order the flange mounting and tube clip separately.
- 2) exhaust open