

Series H-Controlair®

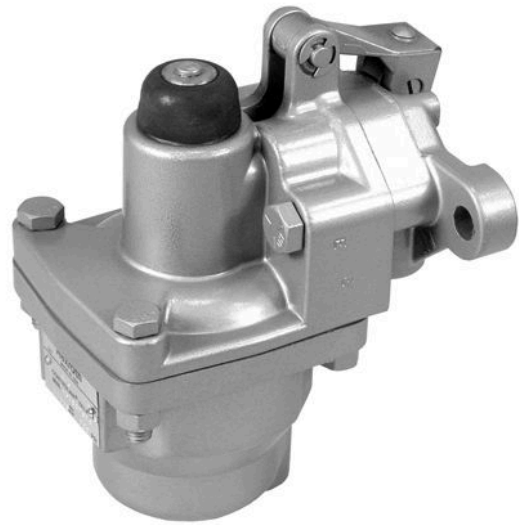

Technical data

Industry	Industrial
Type	Version H-3
Type	Poppet valve
Actuating element	Roller
Type	H-3
Compressed air connection input	1/4 NPT
Compressed air connection output	1/4 NPT
Min. working pressure	0.1 bar
Max. working pressure	14 bar
Min. regulation range	0.1 bar
Max. regulation range	4.5 bar
Min. ambient temperature	-40 °C
Max. ambient temperature	70 °C
Min. medium temperature	-40 °C
Max. medium temperature	70 °C
Medium	Compressed air
Nominal flow Qn	900 l/min
Hysteresis	< 0,1 bar
Weight	2.3 kg

Series H-Controlair®

R431002626

H-
Controlair®

2024-04-02

Housing material	Die-cast aluminum
Seal material	Acrylonitrile butadiene rubber
Part No.	R431002626

Technical information

IN port = pressure supply

OUT port – delivers increasing pressure in direct proportion to pedal depression.

The min. control pressure must be adhered to, since otherwise faulty switching and valve failure may result!

The pressure dew point must be at least 15 °C less than ambient and medium temperature and may not exceed 3 °C.

The oil content of compressed air must remain constant during the life cycle.

Use only the approved oils from AVENTICS. Further information can be found in the “Technical information” document (available in <https://www.emerson.com/en-us/support>).

Series H-Controlair®

R431002626

H-
Controlair®

2024-04-02

Dimensions in inches

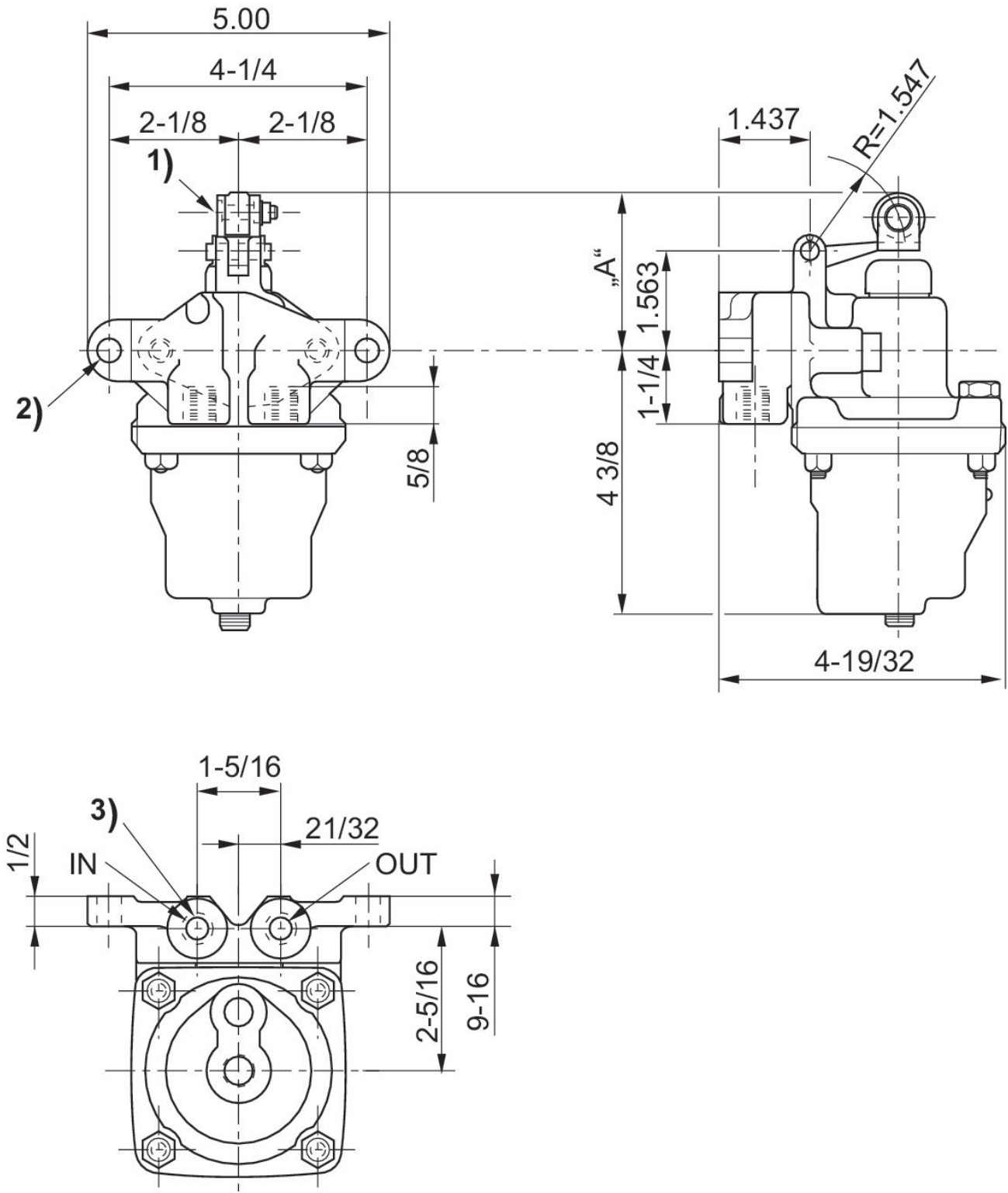

1) 0.031" eccentric screw for total roller adjustment of 0.062" to obtain 2.531" "A" dimension

2) Mounting hole $\varnothing 13/32$

3) 1/4 - 18 NPTF