

Series H-Controlair®



Technical data

Industry

Industrial

Type

Version HC-2

OUT port – delivers increasing pressure when lever is moved clockwise from “Off” (facing lever side of valve).

Type

Poppet valve

Actuating element

Lever

Type

HC-2-FX

Compressed air connection input

1/4 NPT

Compressed air connection output

1/4 NPT

Compressed air connection type output

Internal thread

Min. working pressure

0.1 bar

Max. working pressure

14 bar

Min. regulation range

0.1 bar

Max. regulation range

8.6 bar

Min. ambient temperature

-40 °C

Max. ambient temperature

70 °C

Min. medium temperature

-40 °C

Max. medium temperature

70 °C

Medium

Compressed air

Series H-Controlair®

R431002841

H-
Controlair®

2024-04-02

Nominal flow Qn	900 l/min
Hysteresis	< 0,1 bar
Weight	2.3 kg
Housing material	Die-cast aluminum
Seal material	Acrylonitrile butadiene rubber
Material pedal	Die-cast aluminum
Part No.	R431002841

Technical information

IN port = pressure supply

OUT port – delivers increasing pressure when lever is moved clockwise from “Off” (facing lever side of valve).

The min. control pressure must be adhered to, since otherwise faulty switching and valve failure may result!

The pressure dew point must be at least 15 °C less than ambient and medium temperature and may not exceed 3 °C.

The oil content of compressed air must remain constant during the life cycle.

Use only the approved oils from AVENTICS. Further information can be found in the “Technical information” document (available in <https://www.emerson.com/en-us/support>).

Dimensions

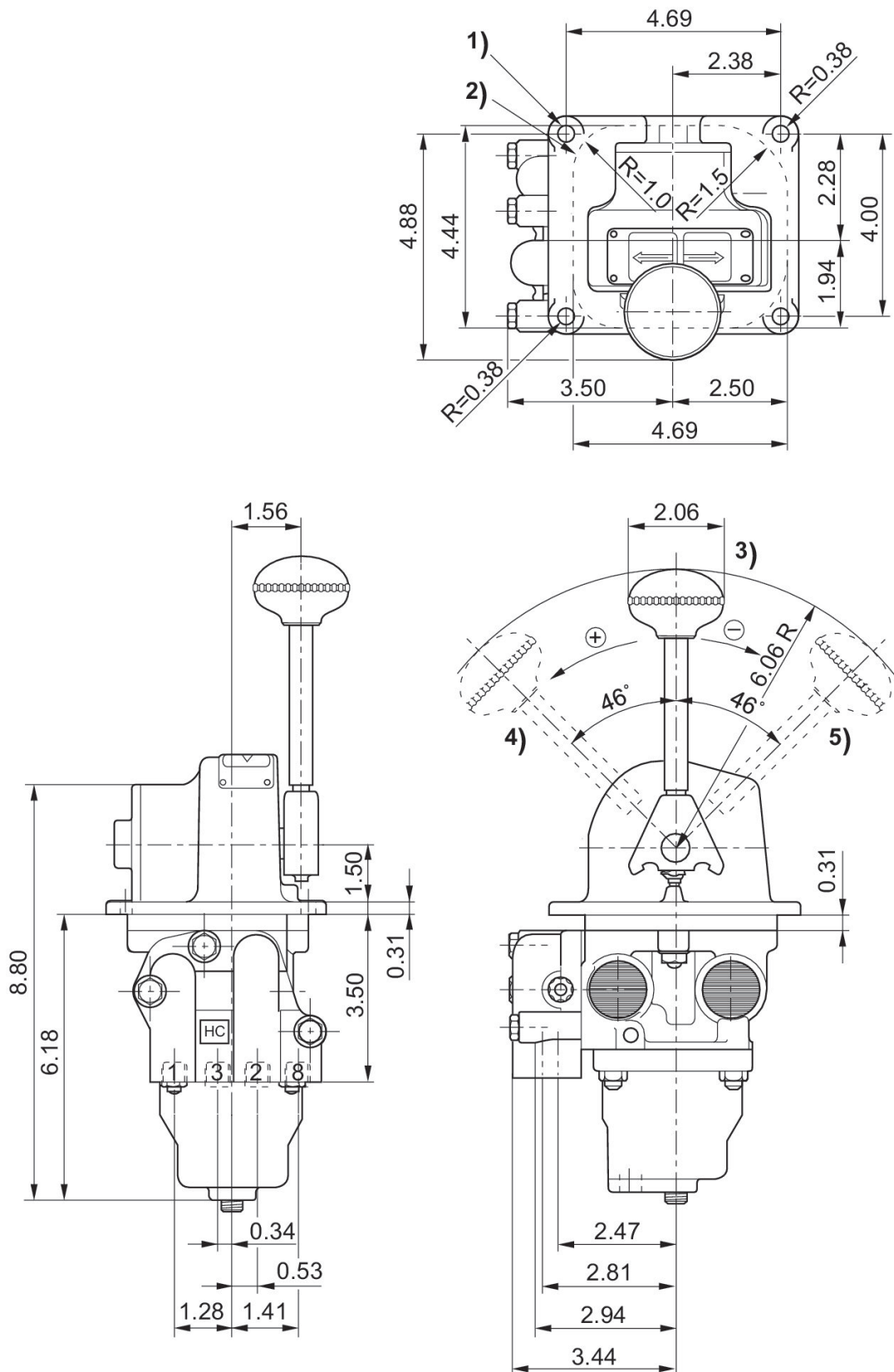

- 1) Mounting hole Ø34
- 2) Air off position

Series H-Controlair®

R431002841

H-
Controlair®

2024-04-02

- 3) Handle position
- 4) Handle position
- 5) Exhaust opening

Function

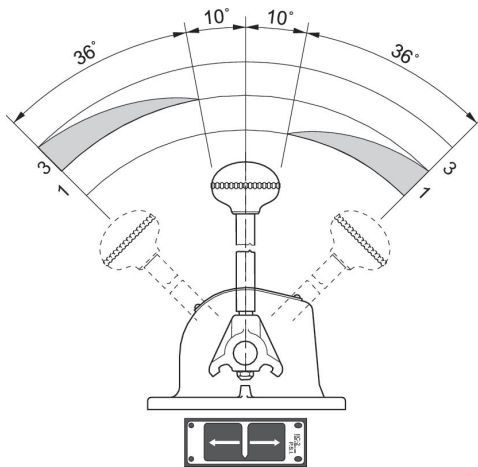

Pressure vs. lever travel