

# Stainless Steel Round Cylinder, Series CSL-RD

R481624923

General series information  
AVENTICS Series CSL-RD Stainless Steel  
Round Cylinders (ISO 6432)

- The AVENTICS Series CSL-RD (ISO 6432) cylinder is a stainless-steel round cylinder, configurable in three different designs: standard, hygienic and short. The Series CSL-RD (ISO 6432) has a smooth profile and low surface roughness made of stainless steel, NSF-H1 grease and FDA compliant seals it is suitable for food contact. In addition, the cylinders are certified in accordance with regulation (EC) No 1935/2004.

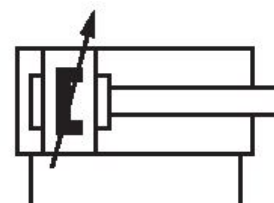

## Technical data

Industry	Industrial
Standards	Based on ISO 6432
Piston Ø	32 mm
Stroke	160 mm
Ports	G 1/8
Functional principle	Double-acting
Cushioning	Pneumatic adjustable cushioning
Magnetic piston	Piston with magnet
Environmental requirements	Industry standard suitable for use in food processing ATEX optional
Piston rod	single
Cylinder special features	Version: short type

Pressure for determining piston forces	6,3 bar
Retracting piston force	435 N
Extracting piston force	505 N
Min. ambient temperature	-20 °C
Max. ambient temperature	80 °C
Working pressure min.	1 bar
Working pressure max	10 bar
Piston rod thread	M10x1,25
Cushioning length	16 mm
Cushioning energy	4.8 J
Weight 0 mm stroke	0.699 kg
Weight +10 mm stroke	0.015 kg
Stroke max.	1200 mm
Medium	Compressed air
Min. medium temperature	-20 °C
Max. medium temperature	80 °C
Max. particle size	50 µm
Oil content of compressed air min.	0 mg/m <sup>3</sup>
Oil content of compressed air max.	5 mg/m <sup>3</sup>
Clamping piece for magnetic field sensor necessary	Clamping piece for magnetic field sensor necessary

## Material

Piston rod	Stainless Steel
Scraper material	Thermoplastic polyurethane (TPU) Ultra-high-molecular-weight polyethylene (UHMW-PE)
Material, front cover	Stainless Steel
Cylinder tube	Stainless Steel
End cover	Stainless Steel
Piston seal	Nitrile butadiene rubber
Nut for cylinder mounting	Stainless Steel
Nut for piston rod	Stainless Steel
Guide bushing	Plastic
Part No.	R481624923

## Technical information

ATEX-certified cylinders with identification II 2G Ex h IIC T4 Gb / II 2D Ex h IIIC T135°C Db\_X can be generated in the Internet configurator.

The operating temperature range for ATEX-certified cylinders is -20°C ... 60°C.

The pressure dew point must be at least 15 °C less than ambient and medium temperature and may not exceed 3 °C.

The oil content of compressed air must remain constant during the life cycle.

Use only the approved oils from AVENTICS. Further information can be found in the “Technical information” document (available in <https://www.emerson.com/en-us/support>).

## Dimensions in mm

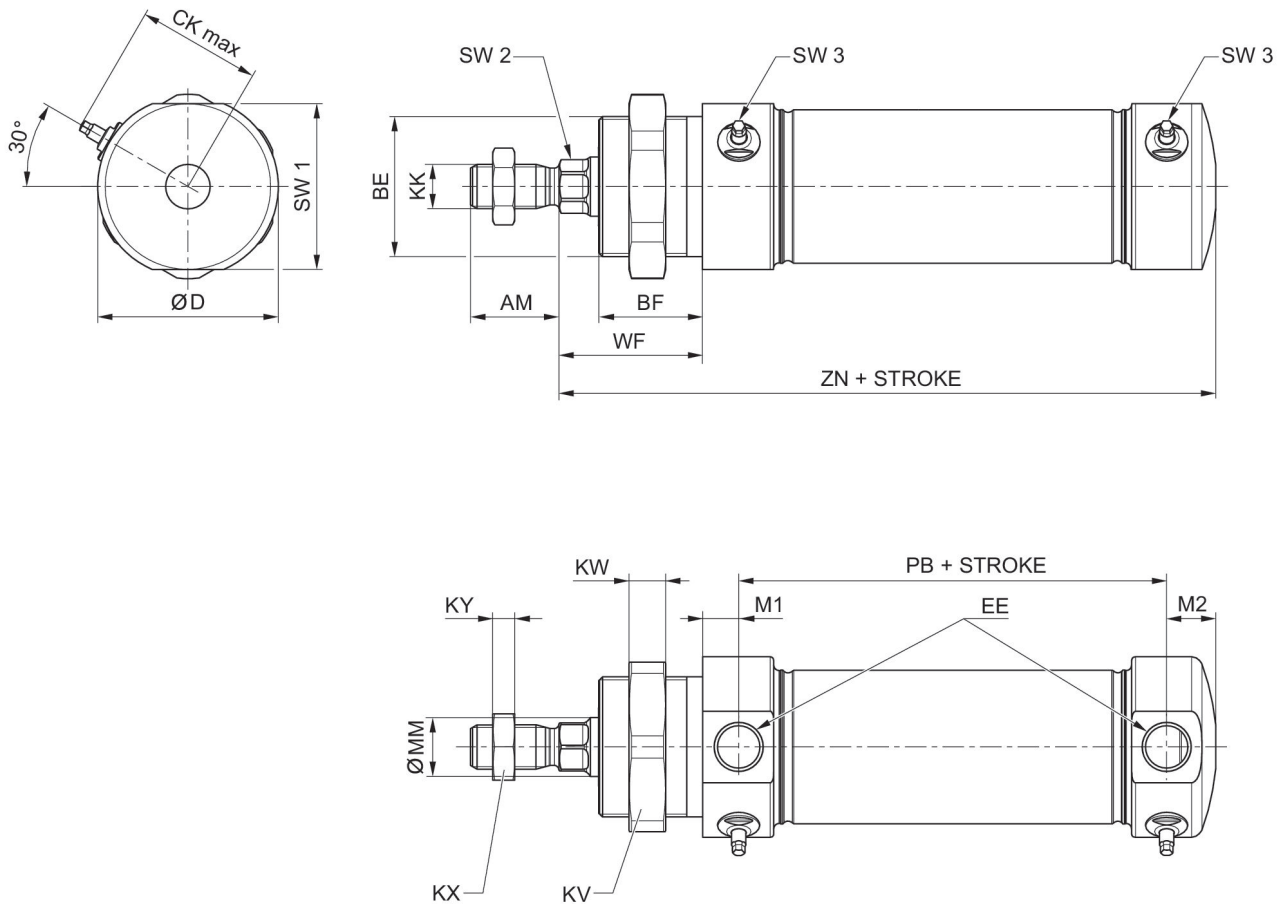

Piston Ø	AM	BE	BF	CK max.	D	EE	KK	KV	KW
32	22	M30x1,5	25	28	38	G 1/8	M10x1,25	36	8
40	24	M38x1,5	28	36,5	49	G 1/4	M12x1,25	46	10

Piston Ø	AM	BE	BF	CK max.	D	EE	KK	KV	KW
50	32	M45x1,5	32	40,5	57	G 1/4	M16x1,5	55	10
63	32	M45x1,5	32	47	70	G 3/8	M16x1,5	55	10

Piston Ø	KX	KY	M1	M2	MM f8	PB ±1	SW 1	SW 2 h13	SW 3
32	17	5	9,5	14,2	12	46	35	10	3
40	18	6	9,8	13,3	16	66	45	13	3
50	24	8	9,8	12,6	20	68	53	17	3
63	24	8	13	14,5	20	71,5	66	17	3

Piston Ø	SW4	WF	ZN
32	24	34	104
40	30	39	128,2
50	34	44	134,5
63	34	44	143,2

## Cushioning diagram

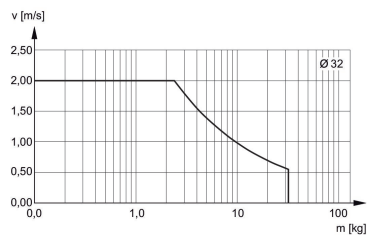

v = Piston velocity [m/s] m = Cushionable mass [kg]

## Overview drawing



NOTE: This overview drawing is only for orientation to indicate where the various accessory parts can be fastened to the cylinder. The illustration has been simplified for this purpose. It is thus not possible to derive the dimensions from this overview.