

Stainless Steel Round Cylinder, Series CSL-RD

R481624941

General series information
AVENTICS Series CSL-RD Stainless Steel
Round Cylinders (ISO 6432)

- The AVENTICS Series CSL-RD (ISO 6432) cylinder is a stainless-steel round cylinder, configurable in three different designs: standard, hygienic and short. The Series CSL-RD (ISO 6432) has a smooth profile and low surface roughness made of stainless steel, NSF-H1 grease and FDA compliant seals it is suitable for food contact. In addition, the cylinders are certified in accordance with regulation (EC) No 1935/2004.

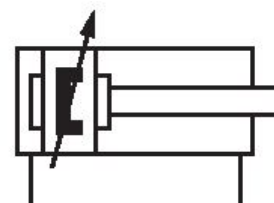

Technical data

| | |
|----------------------------|---|
| Industry | Industrial |
| Standards | Based on ISO 6432 |
| Piston Ø | 50 mm |
| Stroke | 50 mm |
| Ports | G 1/4 |
| Functional principle | Double-acting |
| Cushioning | Pneumatic adjustable cushioning |
| Magnetic piston | Piston with magnet |
| Environmental requirements | Industry standard suitable for use in food processing ATEX optional |
| Piston rod | single |
| Cylinder special features | Version: short type |

| | |
|--|--|
| Pressure for determining piston forces | 6,3 bar |
| Retracting piston force | 1035 N |
| Extracting piston force | 1235 N |
| Min. ambient temperature | -20 °C |
| Max. ambient temperature | 80 °C |
| Working pressure min. | 1 bar |
| Working pressure max | 10 bar |
| Piston rod thread | M16x1,5 |
| Cushioning length | 16 mm |
| Cushioning energy | 15 J |
| Weight 0 mm stroke | 2.044 kg |
| Weight +10 mm stroke | 0.04 kg |
| Stroke max. | 1200 mm |
| Medium | Compressed air |
| Min. medium temperature | -20 °C |
| Max. medium temperature | 80 °C |
| Max. particle size | 50 µm |
| Oil content of compressed air min. | 0 mg/m ³ |
| Oil content of compressed air max. | 5 mg/m ³ |
| Clamping piece for magnetic field sensor necessary | Clamping piece for magnetic field sensor necessary |

Material

| | |
|---------------------------|--|
| Piston rod | Stainless Steel |
| Scraper material | Thermoplastic polyurethane (TPU) Ultra-high-molecular-weight polyethylene (UHMW-PE) |
| Material, front cover | Stainless Steel |
| Cylinder tube | Stainless Steel |
| End cover | Stainless Steel |
| Piston seal | Nitrile butadiene rubber |
| Nut for cylinder mounting | Stainless Steel |
| Nut for piston rod | Stainless Steel |
| Guide bushing | Plastic |
| Part No. | R481624941 |

Technical information

ATEX-certified cylinders with identification II 2G Ex h IIC T4 Gb / II 2D Ex h IIIC T135°C Db_X can be generated in the Internet configurator.

The operating temperature range for ATEX-certified cylinders is -20°C ... 60°C.

The pressure dew point must be at least 15 °C less than ambient and medium temperature and may not exceed 3 °C.

The oil content of compressed air must remain constant during the life cycle.

Use only the approved oils from AVENTICS. Further information can be found in the “Technical information” document (available in <https://www.emerson.com/en-us/support>).

Dimensions in mm

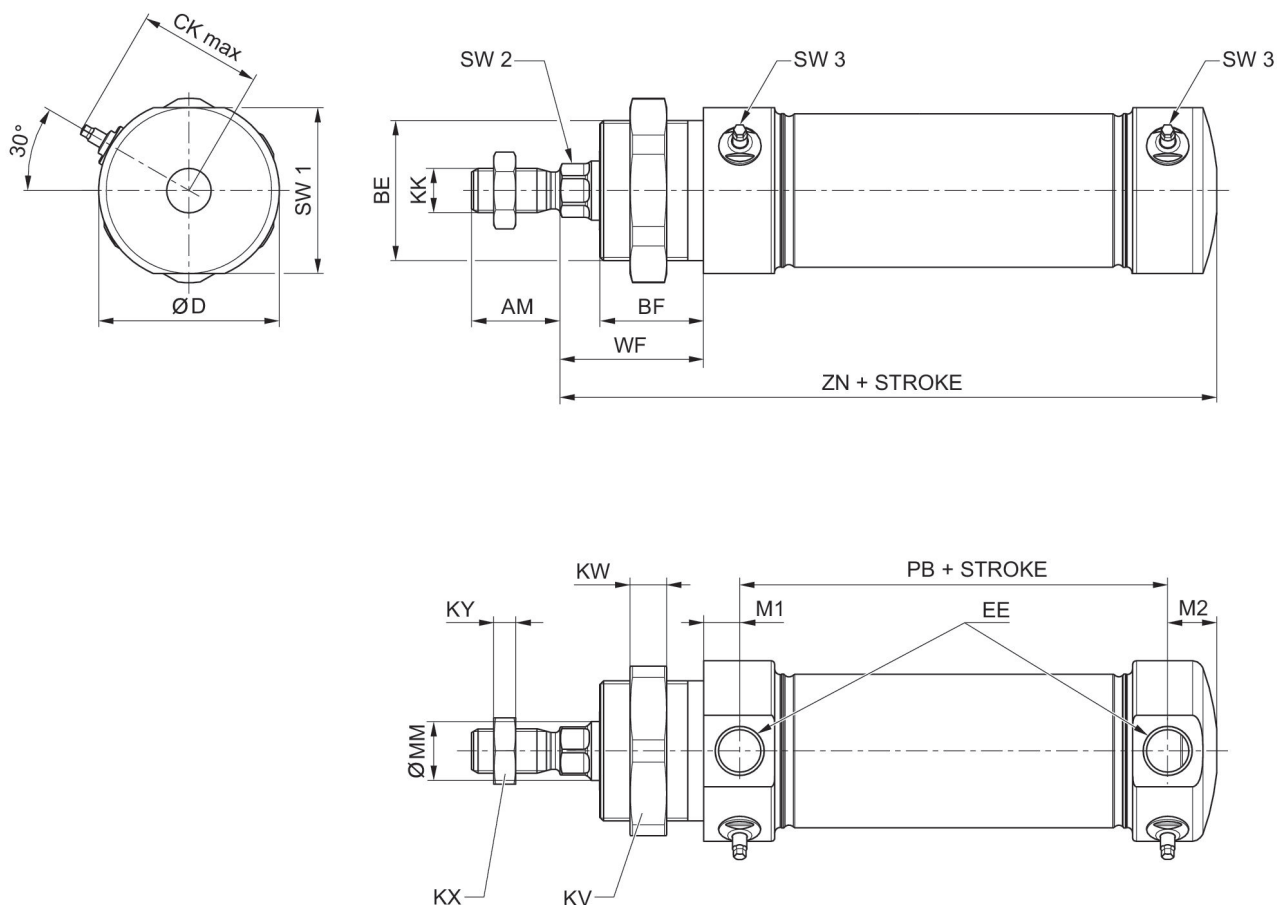

| Piston Ø | AM | BE | BF | CK max. | D | EE | KK | KV | KW |
|----------|----|---------|----|---------|----|-------|----------|----|----|
| 32 | 22 | M30x1,5 | 25 | 28 | 38 | G 1/8 | M10x1,25 | 36 | 8 |
| 40 | 24 | M38x1,5 | 28 | 36,5 | 49 | G 1/4 | M12x1,25 | 46 | 10 |

| Piston Ø | AM | BE | BF | CK max. | D | EE | KK | KV | KW |
|----------|----|---------|----|---------|----|-------|---------|----|----|
| 50 | 32 | M45x1,5 | 32 | 40,5 | 57 | G 1/4 | M16x1,5 | 55 | 10 |
| 63 | 32 | M45x1,5 | 32 | 47 | 70 | G 3/8 | M16x1,5 | 55 | 10 |

| Piston Ø | KX | KY | M1 | M2 | MM f8 | PB ±1 | SW 1 | SW 2 h13 | SW 3 |
|----------|----|----|-----|------|-------|-------|------|----------|------|
| 32 | 17 | 5 | 9,5 | 14,2 | 12 | 46 | 35 | 10 | 3 |
| 40 | 18 | 6 | 9,8 | 13,3 | 16 | 66 | 45 | 13 | 3 |
| 50 | 24 | 8 | 9,8 | 12,6 | 20 | 68 | 53 | 17 | 3 |
| 63 | 24 | 8 | 13 | 14,5 | 20 | 71,5 | 66 | 17 | 3 |

| Piston Ø | SW4 | WF | ZN |
|----------|-----|----|-------|
| 32 | 24 | 34 | 104 |
| 40 | 30 | 39 | 128,2 |
| 50 | 34 | 44 | 134,5 |
| 63 | 34 | 44 | 143,2 |

Cushioning diagram

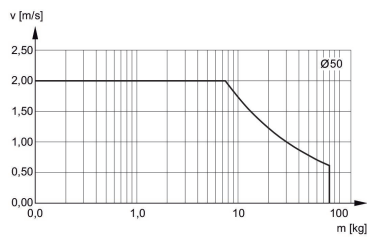

v = Piston velocity [m/s] m = Cushionable mass [kg]

Overview drawing

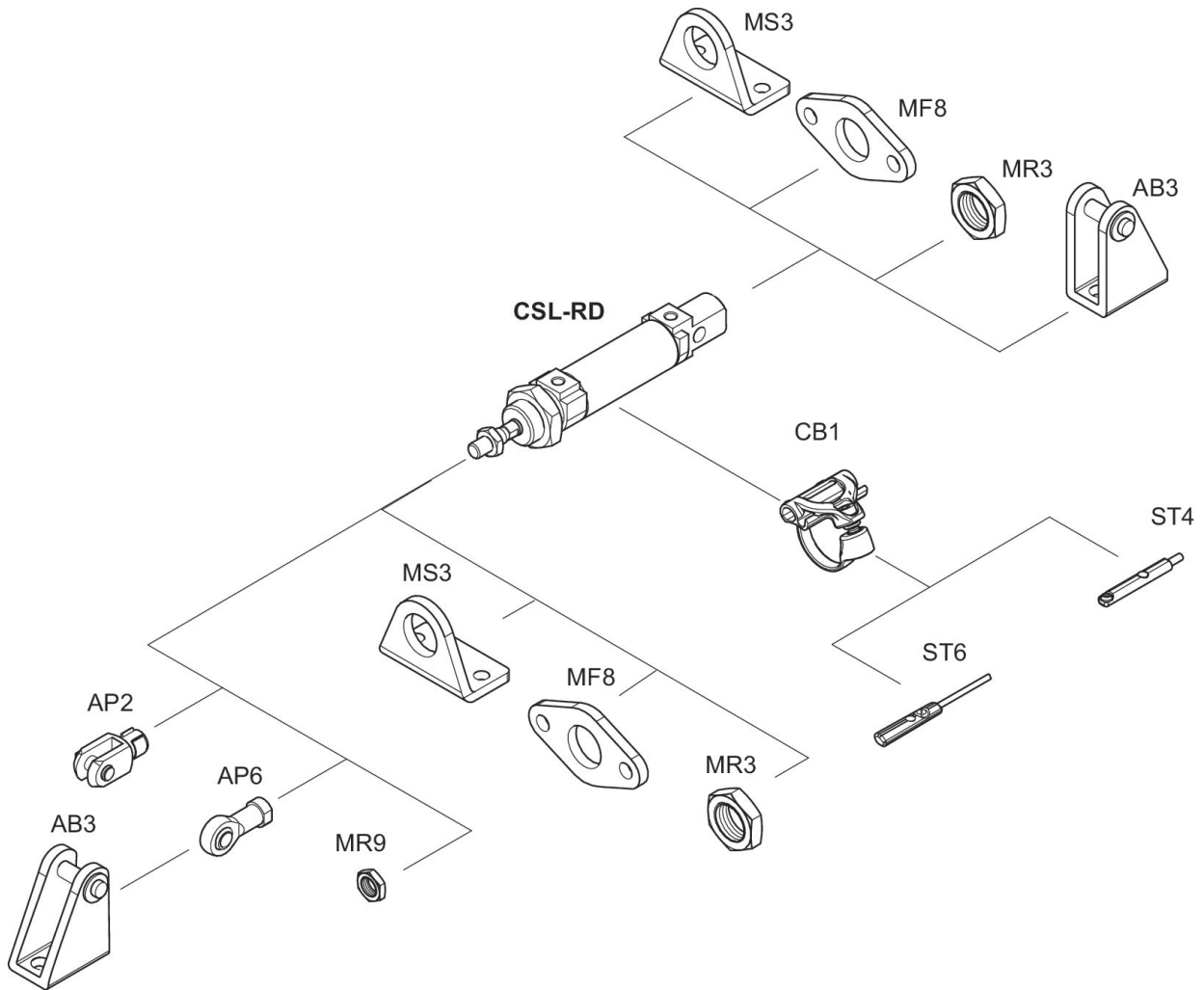

NOTE: This overview drawing is only for orientation to indicate where the various accessory parts can be fastened to the cylinder. The illustration has been simplified for this purpose. It is thus not possible to derive the dimensions from this overview.