

Multiple connector

R412010004

AVENTICS
Distributors
and
distributor
strips

AVENTICS Distributors and distributor strips



Technical data

Industry	Industrial
Type	Distributor 3x
Port G	G 1/8
Working pressure min.	0 bar
Working pressure max	16 bar
Min. ambient temperature	-20 °C
Max. ambient temperature	80 °C

Material

Housing material	Aluminum
Surface housing	anodized
Part No.	R412010004

Multiple connector

R412010004

AVENTICS
Distributors
and
distributor
strips

Dimensions

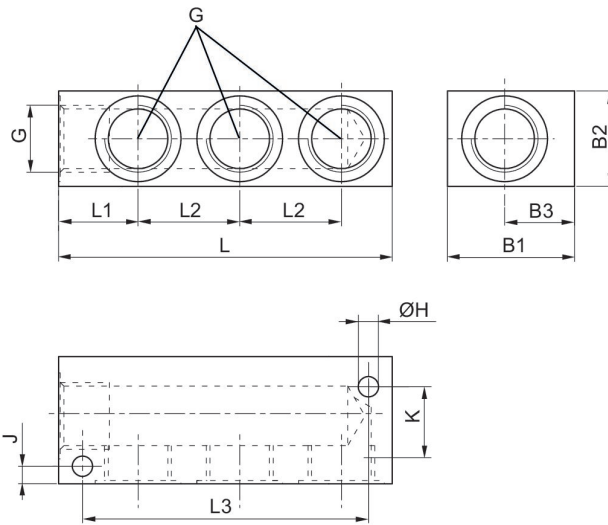

Part No.	G	B1	B2	B3	ØH	J	K	L	L1
R412010004	G1/8	20	20	12	4.4	3.5	13	56	13.5
R412010003	G1/4	30	30	17	6.4	6.5	17	89	20
R412010005	G3/8	40	30	19	6.4	5.5	20	85	20
R412010002	G1/2	40	30	22	6.4	5.5	25	105	25

Part No.	L2	L3
R412010004	17	46
R412010003	29	74
R412010005	26	72
R412010002	32	90