

3/2-directional valve, Series DO22, G1/8

0820019313

Series DO

2024-10-01

- Various connection options possible
- Assembly takes place on manifold strips
- Extensive voltage range
- ATEX version available

AVENTICS Series DO Directional valves

The AVENTICS Series DO offer a simple, reliable and robust solution for all classical pilot control functions with direct electrical operation.

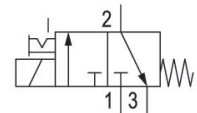

Technical data

Industry

Industrial

Activation

Electrically

Note

Archive product: Do not use in new constructions!

Frame size

DO22

Valve type

Poppet valve

Switching principle

3/2, with spring return

Valve function

NC

Sealing principle

Soft seal

Connection type

Pipe connection

Manual override

with detent

Compressed air connection

G 1/8

Compressed air connection input

G 1/8

Compressed air connection output

G 1/8

Compressed air connection, exhaust

M5

Nominal flow Qn

72 l/min

Nominal flow Qn 1 to 2

72 l/min

3/2-directional valve, Series DO22, G1/8

Series DO

0820019313

2024-10-01

Nominal flow Qn 2 to 3	88 l/min
Min. working pressure	0 bar
Max. working pressure	7 bar
Electrical connection type	Plug
Electrical connection size	ISO 6952, form B
Protection class with connection	IP65
Operational voltage	110 V AC
Operational voltage AC at 60 Hz	110 V
Voltage tolerance AC 60 Hz	-10 % / +10 %
Coil width	22 mm
Compatibility index	14
Holding power AC 60 Hz	6.9 VA
Switch-on power AC 60 Hz	9.4 VA
Duty cycle	100 %
Min. ambient temperature	-10 °C
Max. ambient temperature	50 °C
Min. medium temperature	-10 °C
Max. medium temperature	50 °C
Medium	Compressed air
Min. oil content of compressed air	0 mg/m ³
Max. oil content of compressed air	5 mg/m ³
Max. particle size	5 µm
Mounting screws	M4
Weight	0.11 kg
Material	
Housing material	Polyamide
Seal material	Fluorocautchouc
Part No.	0820019313

Technical information

The min. control pressure must be adhered to, since otherwise faulty switching and valve failure may result!

The pressure dew point must be at least 15 °C less than ambient and medium temperature and may not exceed 3 °C.

The oil content of compressed air must remain constant during the life cycle.

Use only the approved oils from AVENTICS. Further information can be found in the “Technical information” document (available in <https://www.emerson.com/en-us/support>).

Dimensions

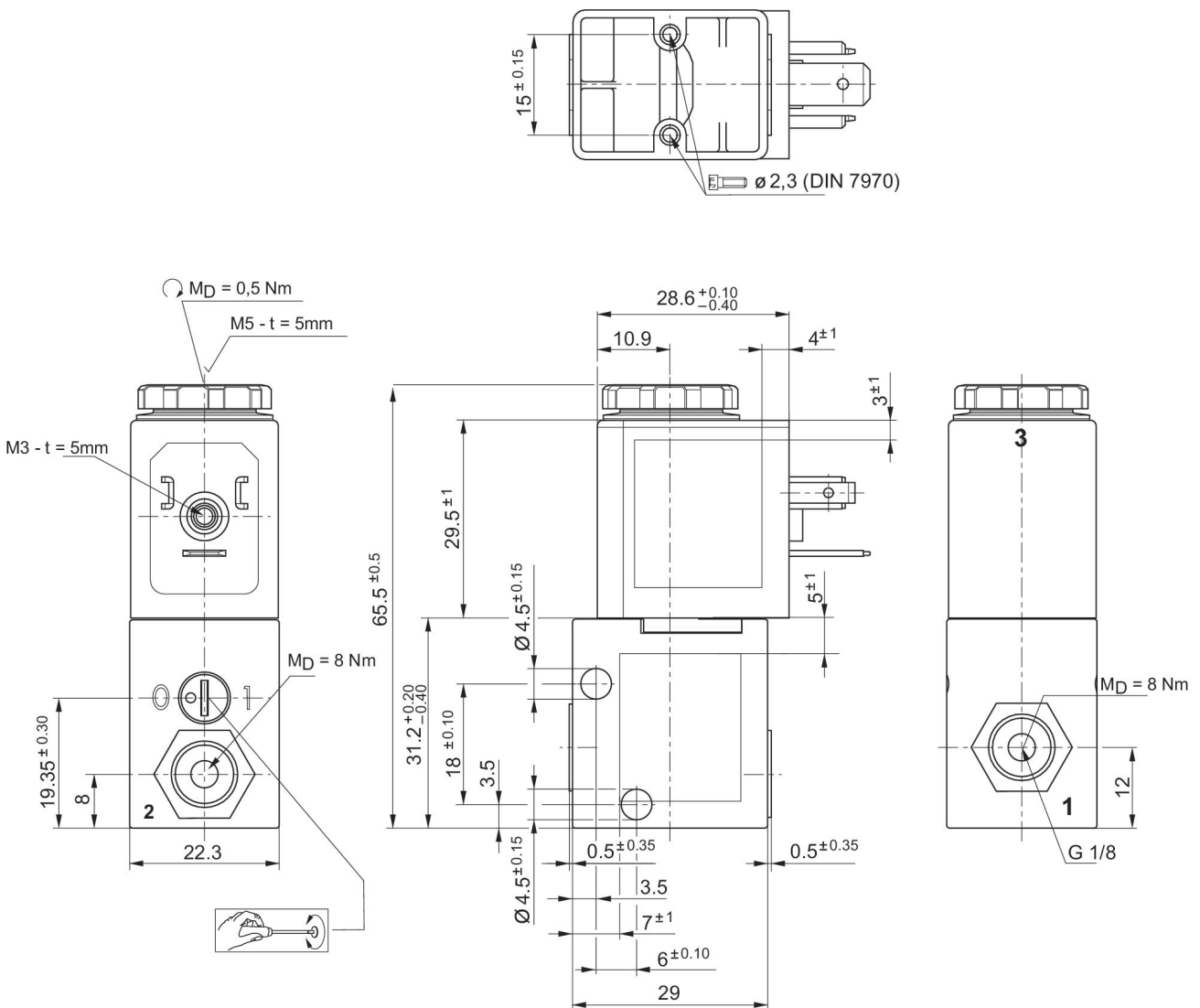

t = depth
MD = maximum torque