

3/2-directional valve, Series DO35

0820005102

General series information
AVENTICS Series DO Directional valves

- The AVENTICS Series DO offer a simple, reliable and robust solution for all classical pilot control functions with direct electrical operation.

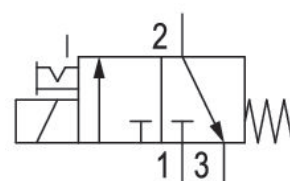

Technical data

Industry	Industrial
Activation	Electrically
Switching principle	3/2, with spring return
Function	NC
Compressed air connection output	G 1/8
Compressed air connection input	G 1/8
Compressed air connection, exhaust	G 1/8
Working pressure min.	0 bar
Working pressure max	10 bar
Operational voltage	110 V AC
Operational voltage AC at 60 Hz	110 V
Voltage tolerance AC 60 Hz	-10% / +10%
Manual override	with detent

Electrical connection type	Plug
Electrical connection size	EN 175301-803, form A
Valve type	Poppet valve
Sealing principle	Soft Seal
Connection type	Pipe connection
Min. ambient temperature	-10 °C
Max. ambient temperature	50 °C
Min. medium temperature	-10 °C
Max. medium temperature	50 °C
Medium	Compressed air
Max. particle size	5 µm
Oil content of compressed air min.	0 mg/m ³
Oil content of compressed air max.	5 mg/m ³
Nominal flow Qn 1 to 2	140 l/min
Nominal flow Qn 2 to 3	130 l/min
Holding power AC 50 Hz	14 VA
Switch-on power AC 50 Hz	21 VA
Duty cycle	100 %
Protection class with connection	IP65
mounting screws	M5

Material

Seal material	Fluorocaoutchouc
Part No.	0820005102

Technical information

The min. control pressure must be adhered to, since otherwise faulty switching and valve failure may result!

The pressure dew point must be at least 15 °C under ambient and medium temperature and may not exceed 3 °C .

The oil content of compressed air must remain constant during the life cycle.

Use only the approved oils from AVENTICS. Further information can be found in the "Technical information" document (available in <https://www.emerson.com/en-us/support>).

manifold valve

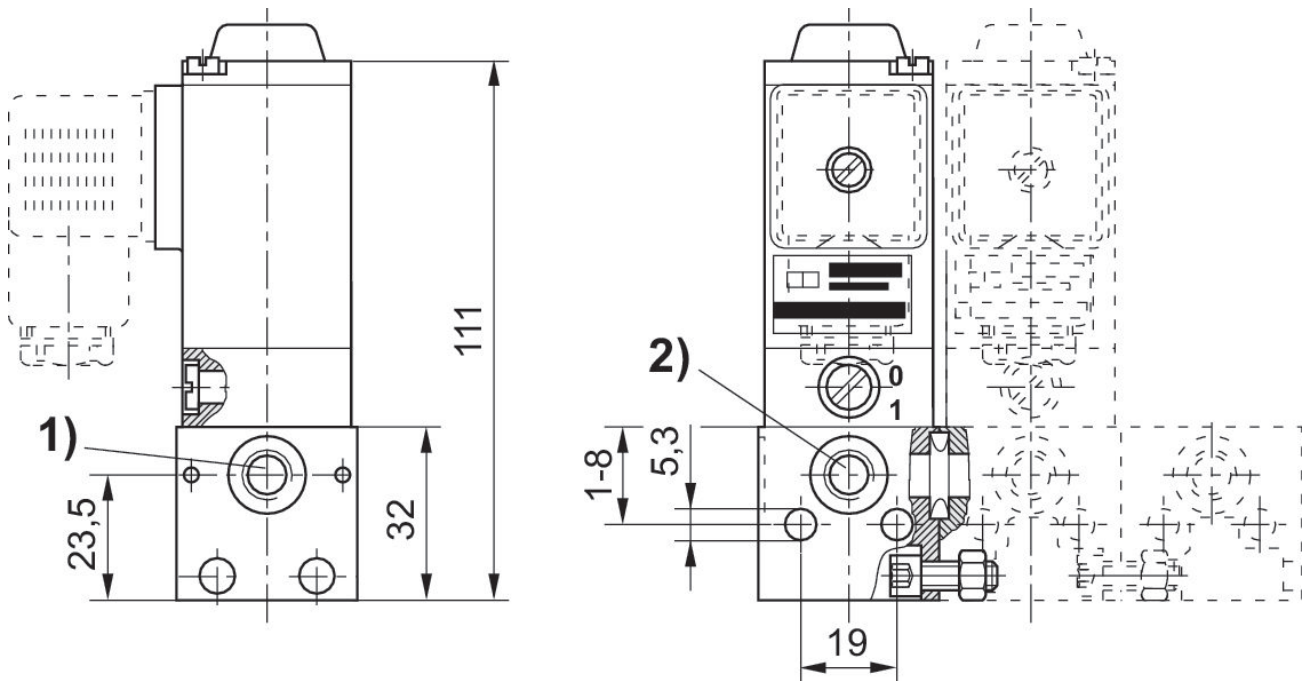

Scope of delivery: 2 screws M5x12, 2 nuts M5 DIN 934, 1 O-ring
1) Port 1 (Input)
2) Port 2 (Output)

single connecting valve

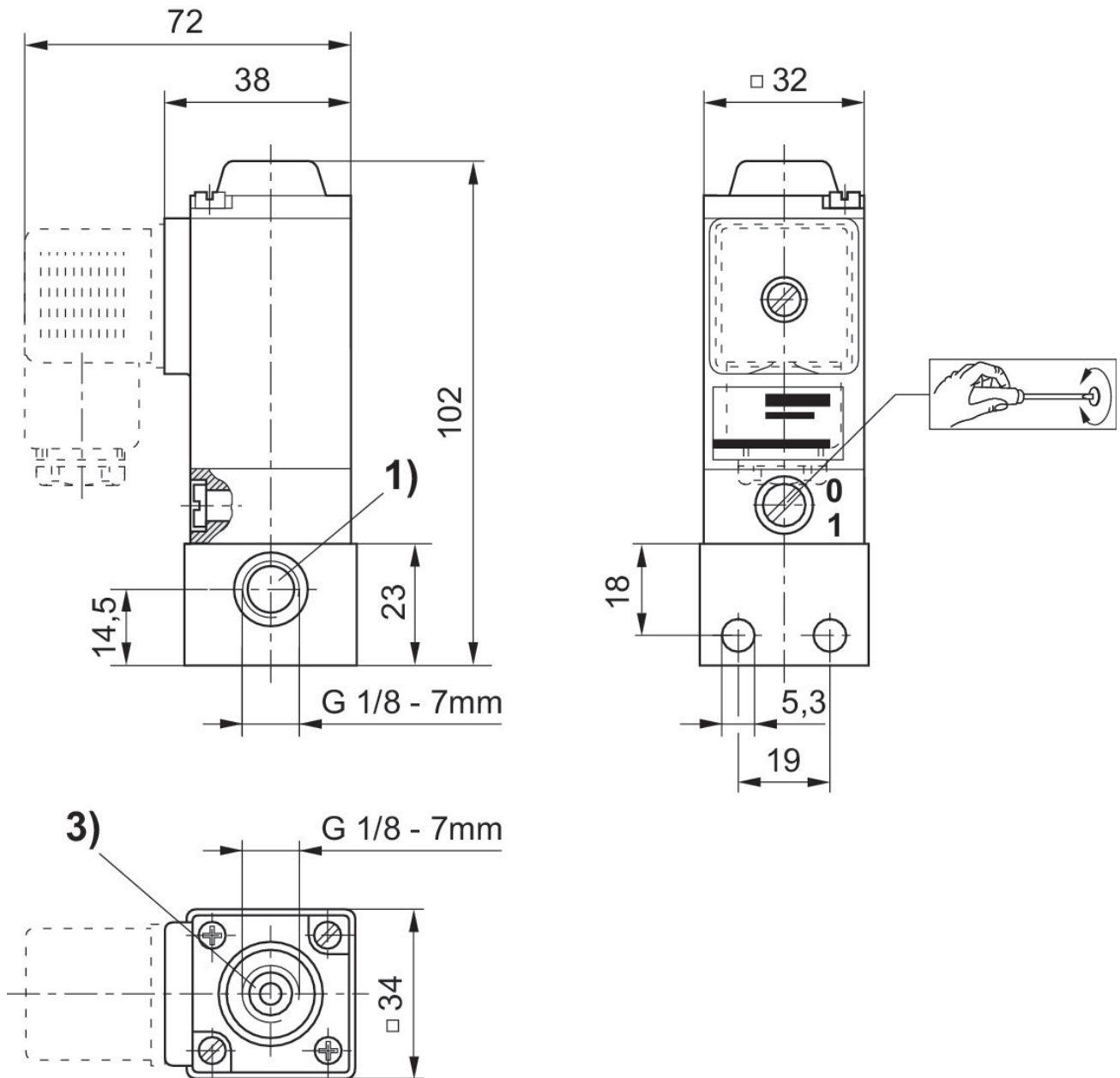

- 1) Port 1 (Input)
- 3) Port 3 (Exhaust)