

AVENTICS Series EBS Ejectors

The AVENTICS Series EBS ejectors are the convincing and talented multi-taskers within the AVENTICS ejector Series. Parallel to the main advantages of this ejector Series, these ejectors offer additional benefits due to their enormous versatility.

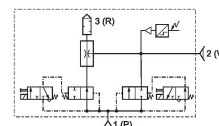
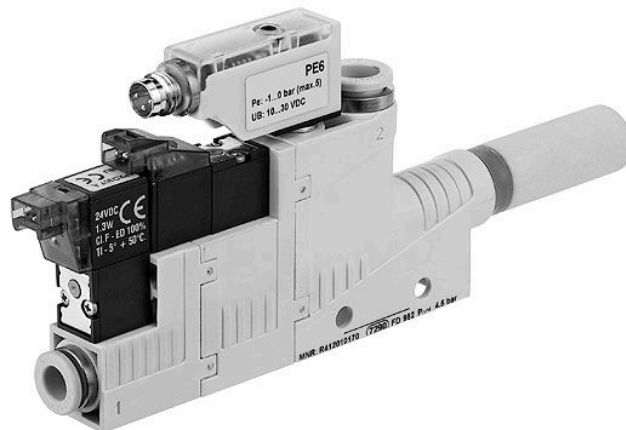

Technical data

Industry	Industrial
Activation	Electrically
Note	push-in fitting
Type	Ejector
Version	electrical control, T-design
with silencer	with silencer
Nozzle Ø	2.5 mm
vacuum switch	electronic adjustable
Min. working pressure	3 bar
Max. working pressure	6 bar
Min. ambient temperature	0 °C
Max. ambient temperature	50 °C
Min. medium temperature	0 °C
Max. medium temperature	50 °C
Medium	Compressed air
Min. oil content of compressed air	0 mg/m ³
Max. oil content of compressed air	1 mg/m ³
Max. particle size	5 µm
Compressed air connection	Ø 8

Ejector, Series EBS

2024-02-20

R412010173

Vacuum connection+	Ø 8
Max. suction capacity	223 l/min
Air consumption at p.opt.	320 l/min
Max. vacuum level at p.opt	84 %
Sound pressure level intake effect	70 dB
Sound pressure level intake effect	78 dB
Protection against overpressure (max.) release valve	5 bar release valve
Protection class	IP40
Duty cycle according to DIN VDE 0580 standard	100 %
Operational voltage DC	24 V
Hysteresis	2% of the final value, fixed
Precision (% of full scale value)	± 3 %
Repeatability (% of full scale value)	± 1 %
Voltage tolerance DC	- 5% / +10%
Power consumption solenoid valve	1.3 W
Switching point	adjustable 0 ... 100%
Weight	0.154 kg
Housing material	Polyamide fiber-glass reinforced
Seal material	Acrylonitrile butadiene rubber
Nozzle material	Aluminum
Silencer material	Polyethylene
Material pressure sensor	Polycarbonate
Part No.	R412010173

Technical information

Note: All data refers to an ambient pressure of [[1,013] bar] and an ambient temperature of [[20]°C].
The pressure dew point must be at least 15 °C less than ambient and medium temperature and may not exceed 3 °C.

Ejector, Series EBS

2024-02-20

R412010173

Fig. 2

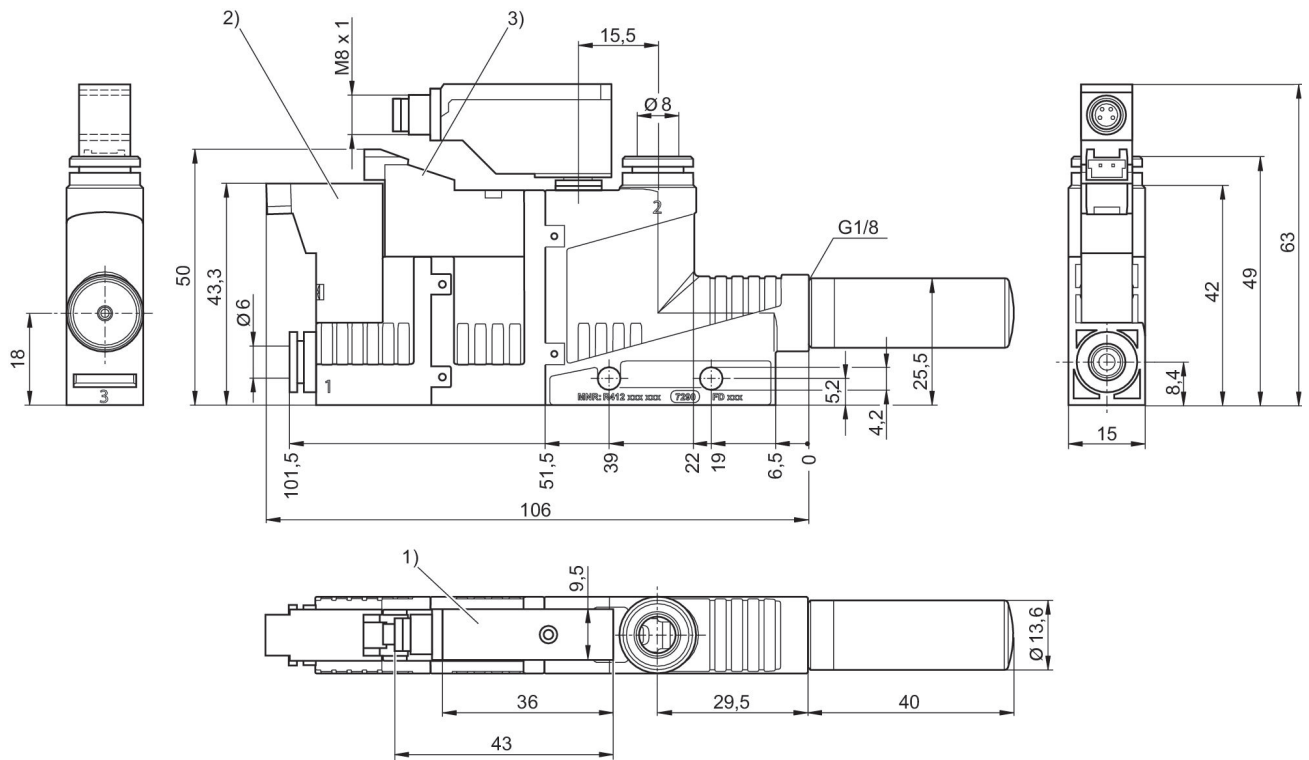

- 1) vacuum switch is rotatable and exchangeable
- 2) Solenoid valve for vacuum ON/OFF
- 3) Solenoid valve for release pulse

Fig. 3

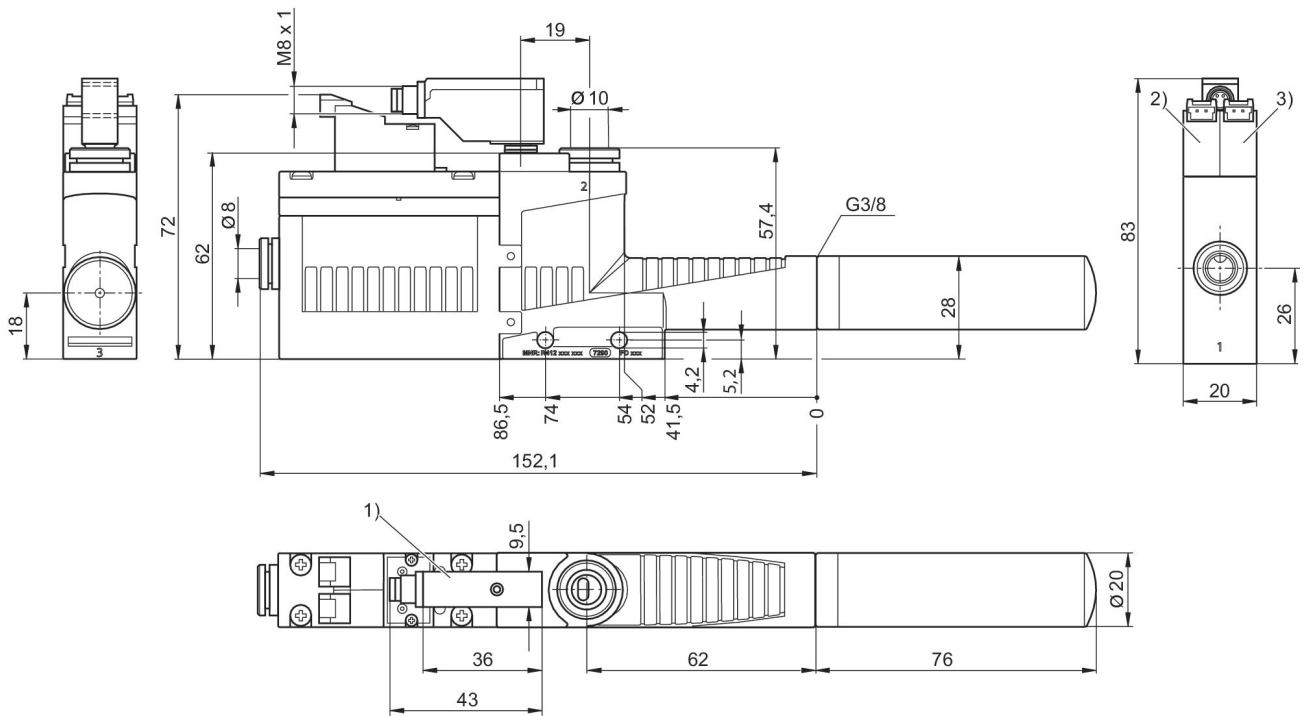

- 1) vacuum switch is rotatable and exchangeable
- 2) Solenoid valve for vacuum ON/OFF
- 3) Solenoid valve for release pulse

Vacuum p_2 depending on working pressure p_1

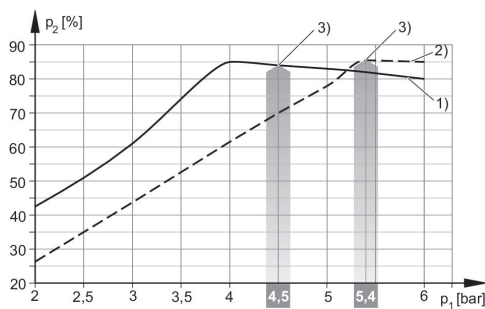

- 1) = \varnothing nozzle 0.5 mm 2) = \varnothing nozzle 0.7 mm
- 3) optimum working pressure

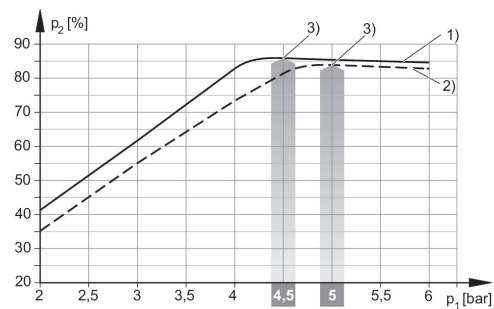

- 1) = \varnothing nozzle 1.0 mm 2) = \varnothing nozzle 1.5 mm
- 3) optimum working pressure

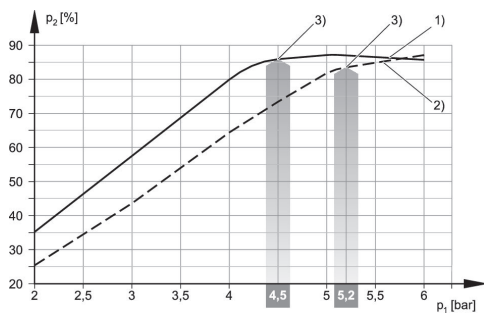

1) = Ø nozzle 2.0 mm 2) = Ø nozzle 2.5 mm
3) optimum working pressure

Suction capacity q_s depending on working pressure p_1

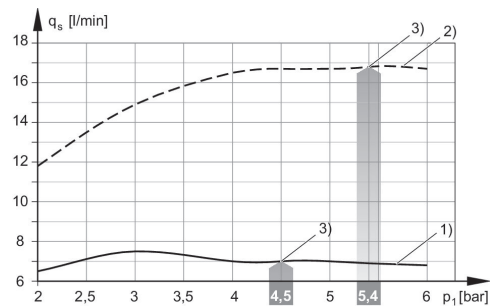

1) = Ø nozzle 0.5 mm 2) = Ø nozzle 0.7 mm
3) optimum working pressure

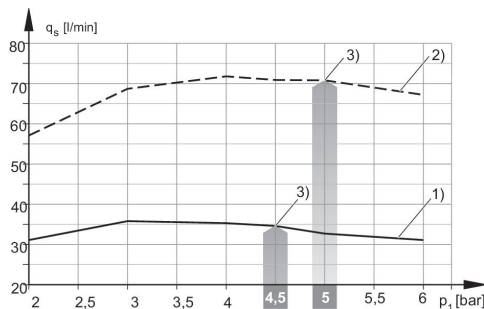

1) = Ø nozzle 1.0 mm 2) = Ø nozzle 1.5 mm
3) optimum working pressure

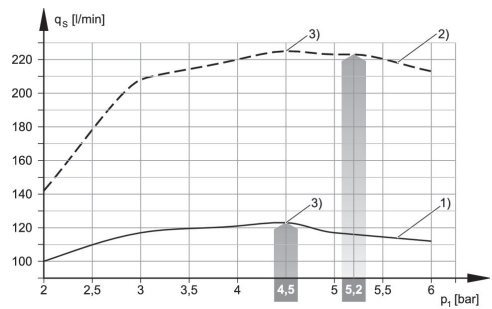

1) = Ø nozzle 2.0 mm 2) = Ø nozzle 2.5 mm
3) optimum working pressure

Evacuation time t_E depending on vacuum p_2 for 1 l volume (with optimal operating pressure p_{1opt})

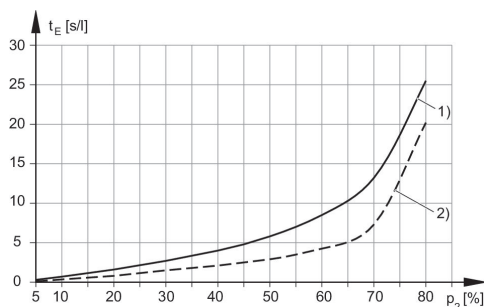

1) = Ø nozzle 0.5 mm 2) = Ø nozzle 0.7 mm

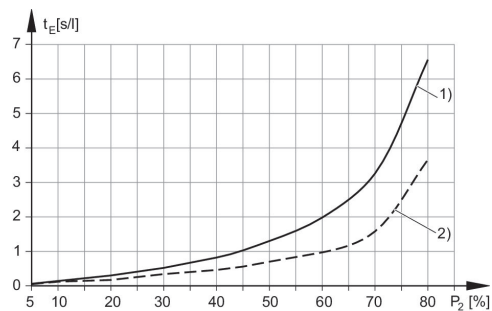

1) = Ø nozzle 1.0 mm 2) = Ø nozzle 1.5 mm

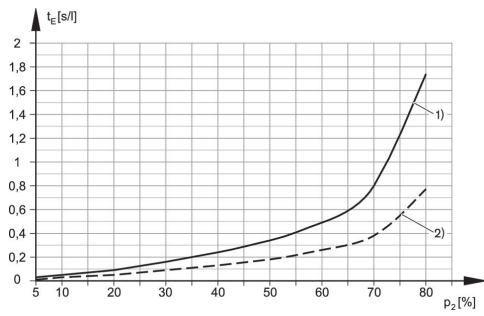

1) = \emptyset nozzle 2.0 mm 2) = \emptyset nozzle 2.5 mm

Air consumption q_v depending on working pressure p_1

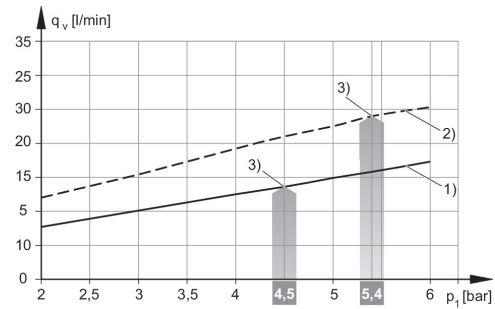

1) = \emptyset nozzle 0.5 mm 2) = \emptyset nozzle 0.7 mm
3) optimum working pressure

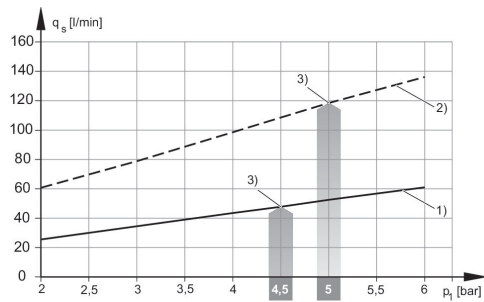

1) = \emptyset nozzle 1.0 mm 2) = \emptyset nozzle 1.5 mm
3) optimum working pressure

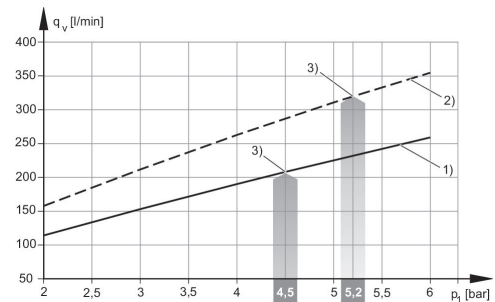

1) = \emptyset nozzle 2.0 mm 2) = \emptyset nozzle 2.5 mm
3) optimum working pressure