

Serie ECD-SV

The AVENTICS Series ECD is an all-inclusive solution that combines vacuum generators, pilot valves, filters, silencers and pressure switches. Simplify installation and optimize your energy footprint by opting for the air economizer function, and increase your degree of status monitoring with the condition monitoring function.

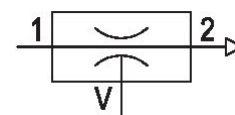
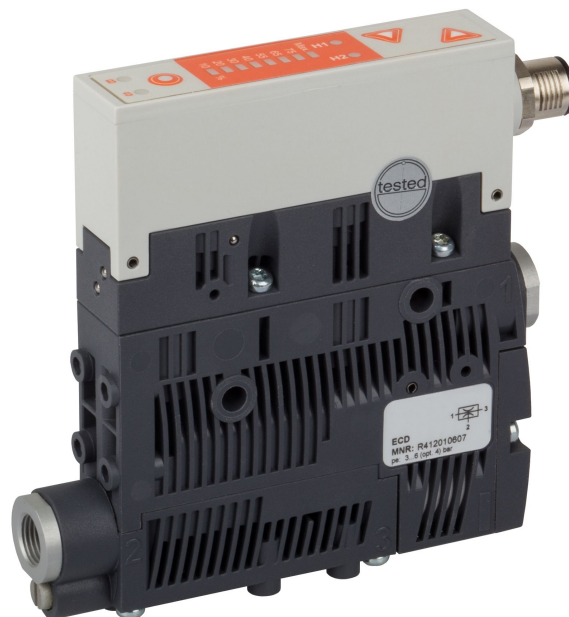

Technical data

Industry	Industrial
Activation	Electrically
Switching logic	NO (make contact)
with silencer	with silencer
Nozzle Ø	1 mm
vacuum switch	electronic
Accessories	with non-return valve
Min. working pressure	2 bar
Max. working pressure	6 bar
Working pressure p.opt.	4 bar
Min. ambient temperature	0 °C
Max. ambient temperature	50 °C
Min. medium temperature	0 °C
Max. medium temperature	50 °C
Medium	Compressed air
Min. oil content of compressed air	0 mg/m ³
Max. oil content of compressed air	1 mg/m ³
Max. particle size	5 µm
Max. suction capacity	35.4 l/min

Air consumption at p.opt.	46.2 l/min
Max. vacuum level at p.opt	81.5 %
Sound pressure level intake effect	63 dB
Sound pressure level intake effect	76 dB
Protection against overpressure (max.) with air economizer release valve	5 bar with air economizer release valve
Protection class according to EN 60529:2000, without electrical connector	IP65
Duty cycle according to DIN VDE 0580 standard	100 %
Operational voltage DC	24 V
Hysteresis	adjustable
Repeatability (% of full scale value)	± 1 %
Voltage tolerance DC	-20 % / +10 %
Switch output current	125 mA
Power consumption solenoid valve	1.3 W
Weight	0.195 kg
Housing material	Polyamide
Seal material	Acrylonitrile butadiene rubber
Nozzle material	Brass
Silencer material	Polyethylene
Part No.	R412010607

Technical information

Note: All data refers to an ambient pressure of $[[1,013]$ bar] and an ambient temperature of $[[20]^{\circ}\text{C}]$.
The pressure dew point must be at least 15 °C less than ambient and medium temperature and may not exceed 3 °C.

The oil content of compressed air must remain constant during the life cycle.

Suction capacity q_s depending on working pressure p_1

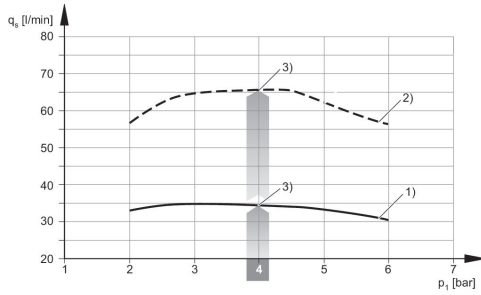

- 1) \varnothing nozzle [[1.0] mm]
- 2) \varnothing nozzle [[1.5] mm]
- 3) optimum working pressure

Vacuum p_2 depending on working pressure p_1

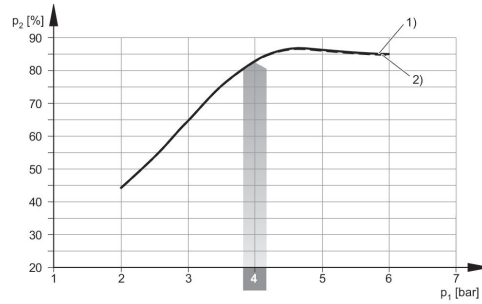

- 1) \varnothing nozzle [[1.0] mm]
- 2) \varnothing nozzle [[1.5] mm]

Noise level, suctioned

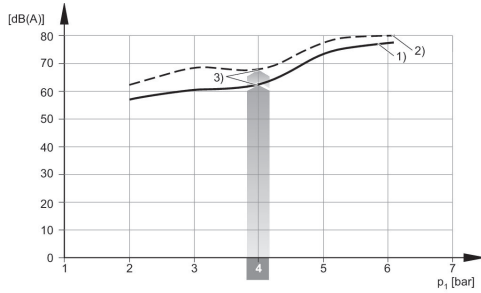

- 1) \varnothing nozzle [[1.0] mm]
- 2) \varnothing nozzle [[1.5] mm]
- 3) optimum working pressure

Noise level at free suctioning

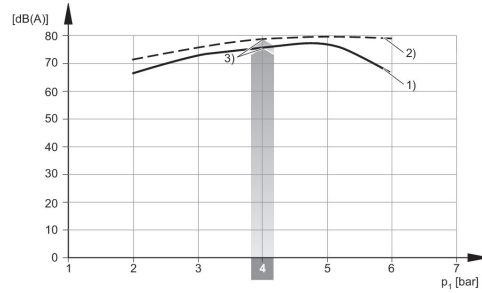

- 1) \varnothing nozzle [[1.0] mm]
- 2) \varnothing nozzle [[1.5] mm]
- 3) optimum working pressure

Circuit diagram ECD-SV-...NC

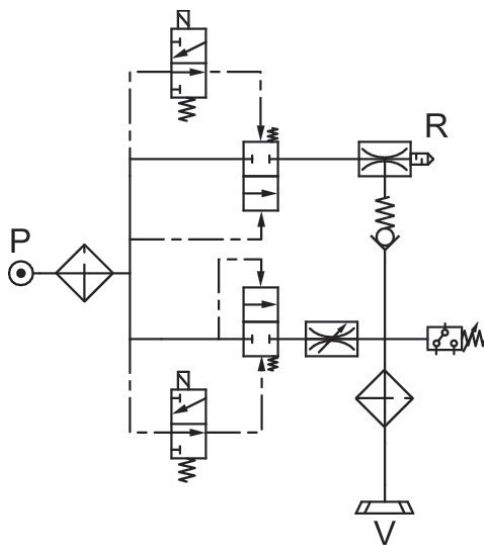

Circuit diagram ECD-SV-...NO

