

E/P pressure regulator, Series ED05

R414002004

Series
ED05

2024-04-30

Series ED05

The AVENTICS ED05 direct-acting pressure regulator ensures sensitive pressure control by combining digital control electronics with innovative proportional technology. The robust poppet valve technology, a large opening cross-section and the use of a soft-sealing valve seat make the valve highly resistant to contamination.

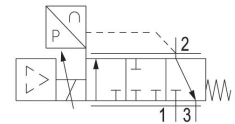

Technical data

Control	Directly controlled
Control	Analog
Function	Air exhaust
Actual output value	Analog
Min. regulation range	0 bar
Max. regulation range	6 bar
Min. working pressure	0 bar
Max. working pressure	11 bar
Hysteresis	< 0,06 bar
Medium	Compressed air
Nominal flow Qn	1000 l/min
Min. ambient temperature	0 °C
Max. ambient temperature	70 °C
Min. medium temperature	0 °C
Max. medium temperature	70 °C
Operational voltage DC	24 V
Protection class	IP65
Permissible ripple	5%
Max. particle size	50 µm

E/P pressure regulator, Series ED05

Series
ED05

R414002004

2024-04-30

Min. oil content of compressed air	0 mg/m ³
Max. oil content of compressed air	1 mg/m ³
Type	Poppet valve
Mounting orientation	$\alpha = 0-90^\circ$ $\beta = 0-90^\circ$
Certificates	CE declaration of conformity
Compressed air connection input	G 1/4
Compressed air connection output	G 1/4
Compressed air connection, exhaust	G 1/4
Electrical connection size	via signal connection
Signal connection	input and output
Signal connection	Plug
Signal connection	M12
Signal connection	5-pin
Actual output value	4 ... 20 mA
Nominal input value	4 ... 20 mA
Industry	Industrial
Weight	0.95 kg

Material

Housing material	Die-cast aluminum Steel, chrome-plated
Seal material	Hydrogenated acrylonitrile butadiene rubber
Part No.	R414002004

Technical information

With oil-free, dry air, other installation positions are possible on request.

The protection class is only ensured when the plug is mounted properly. For detailed information, see operating instructions.

The min. control pressure must be adhered to, since otherwise faulty switching and valve failure may result!

The pressure dew point must be at least 15 °C less than ambient and medium temperature and may not exceed 3 °C.

The oil content of compressed air must remain constant during the life cycle.

Use only the approved oils from AVENTICS. Further information can be found in the "Technical information" document (available in <https://www.emerson.com/en-us/support>).

E/P pressure regulator, Series ED05

R414002004

Series
ED05

2024-04-30

Dimensions

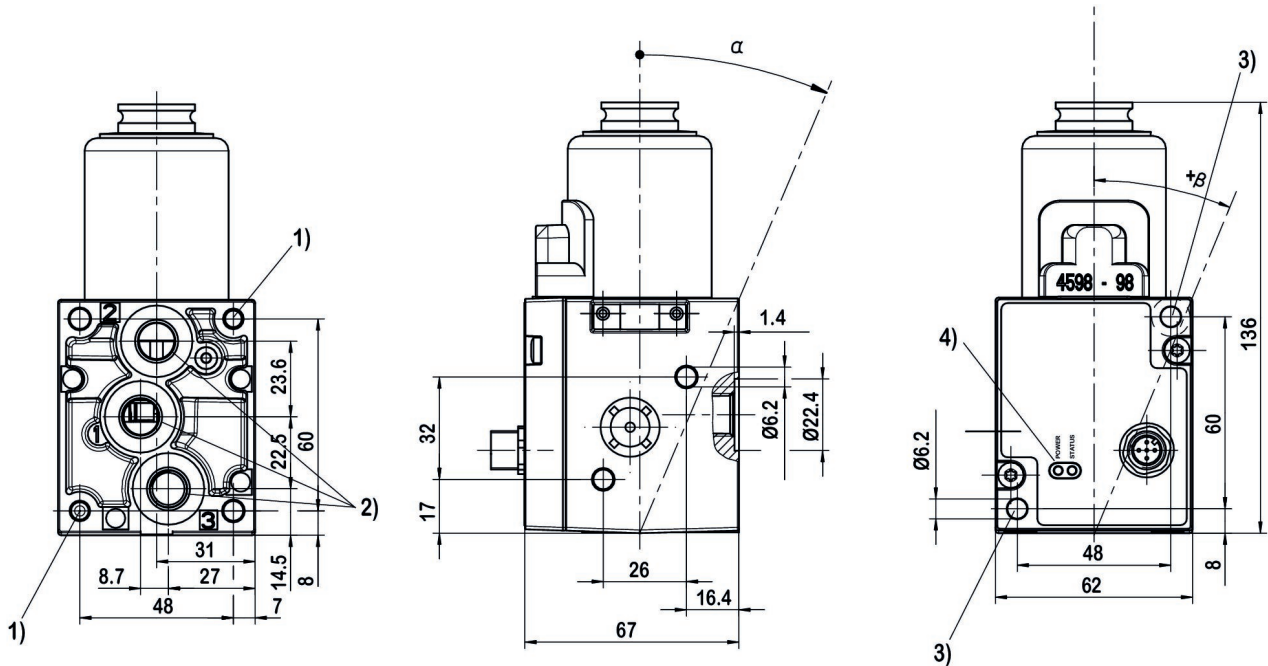

- 1) Core hole 15 mm deep for self-tapping screws M6
- 2) Universal threaded connection, suitable for G1/4 according to ISO 228/1:2000 and 1/4-27 NPTF
- 3) Through hole

Flow diagram

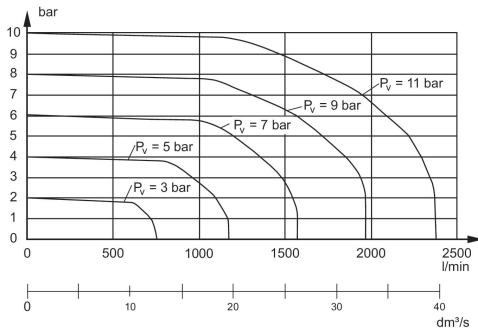

P_v = Supply pressure
Connect the plug via a shielded cable to ensure EMC

Functional diagram

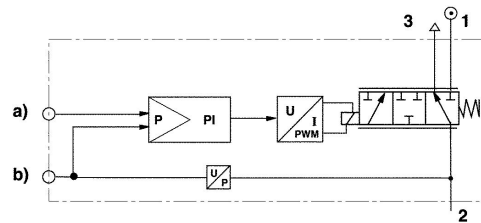

a) Nominal input value b) Actual output value The E/P pressure control valve modulates the pressure corresponding to an analog electrical nominal input value.

- 1) Operating pressure
- 2) Working pressure
- 3) Exhaust

Functional diagram for switch output (acknowledge signal)

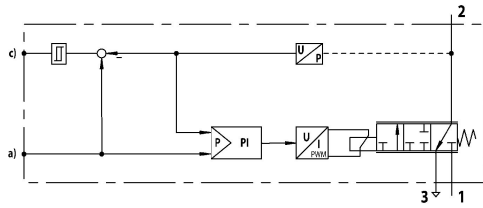

a) Nominal input value c) Switch output (acknowledge signal) The E/P pressure control valve modulates the pressure corresponding to an analog electrical nominal input value.

- 1) Operating pressure
- 2) Working pressure
- 3) Exhaust

Fig. 1 Characteristic and pin assignment for current control with actual output value

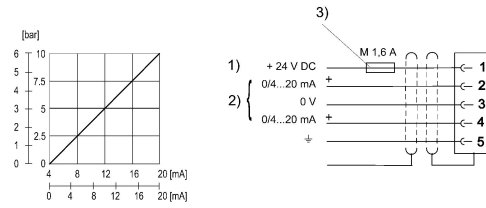

- 1) Operational voltage
- 2) Actual value (pin 4) and nominal value (pin 2) are related to 0 V (control voltage). Nominal input value current (ohmic load 100 Ω). Actual output value (max. total resistance of downstream devices < 300 Ω).
- 3) The operating voltage must be protected by an external M 1.6 A fuse. Connect plug 2 via a shielded cable to ensure EMC.