

AVENTICS ED07 Dynamic Direct Acting Pressure Regulator

The AVENTICS Series ED07 offers proportional pressurization and the exhaust valves are controlled separately to deliver dynamic control for the most demanding applications.

Highly dynamic proportional pressure regulator

Stackable with base plate

Nominal width 7

Flow 1300 l/min

Pressure range -1 ... 20 bar

EtherCAT, AES fieldbus connection

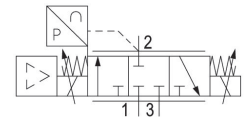
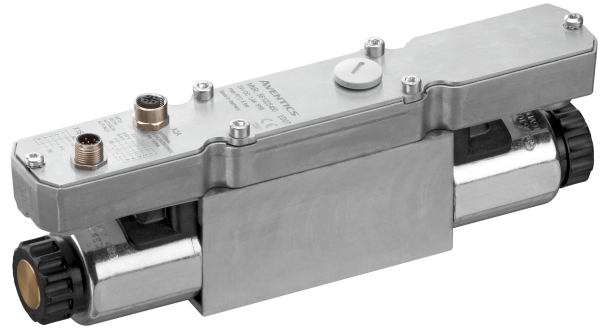

Technical data

Control	Directly controlled
Control	Analog
Function	Air exhaust
Actual output value	Analog Switch output
Min. regulation range	-1 bar
Max. regulation range	1 bar
Min. working pressure	0.5 bar
Max. working pressure	3 bar
Hysteresis	< 0,015 bar
Medium	Compressed air
Nominal flow Qn	1300 l/min
Min. ambient temperature	5 °C
Max. ambient temperature	50 °C
Min. medium temperature	5 °C
Max. medium temperature	50 °C
Operational voltage DC	24 V
Max. current consumption	1400 mA
Protection class	IP65
Permissible ripple	5%

E/P pressure regulator, Series ED07

2024-02-20

R414009647

Max. particle size	50 µm
Max. oil content of compressed air	1 mg/m ³
Type	Poppet valve
Mounting orientation	$\alpha = 0 \dots 90^\circ \pm \beta = 0 \dots 90^\circ$
Certificates	CE declaration of conformity
Electrical connection type	Plug
Electrical connection size	M12
Electrical connection number of poles	5-pin
Signal connection	input and output
Signal connection	Socket
Signal connection	M12
Signal connection	5-pin
Actual output value	0 ... 10 V
Nominal input value	0 ... 10 V
Industry	Industrial
Weight	2.05 kg

Material

Housing material	Die-cast aluminum Steel, chrome-plated
Seal material	Hydrogenated acrylonitrile butadiene rubber
Part No.	R414009647

Technical information

With oil-free, dry air, other installation positions are possible on request.

The protection class is only ensured when the plug is mounted properly. For detailed information, see operating instructions.

Minimum working pressure = $[[0.5] \text{ bar}] + \text{max. required secondary pressure}$

Additional pressure setting ranges available on request

The min. control pressure must be adhered to, since otherwise faulty switching and valve failure may result!

The pressure dew point must be at least 15 °C less than ambient and medium temperature and may not exceed 3 °C.

The oil content of compressed air must remain constant during the life cycle.

Use only the approved oils from AVENTICS. Further information can be found in the "Technical information" document (available in <https://www.emerson.com/en-us/support>).

Mounting orientation

$$\beta = \pm 0 \dots 90^\circ$$

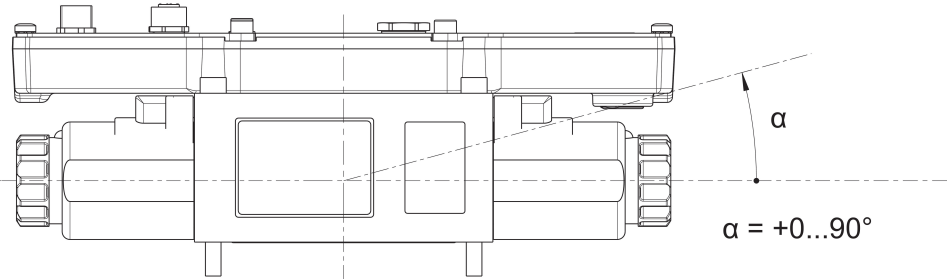
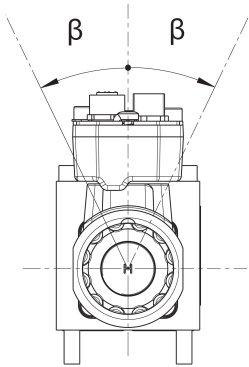

E/P pressure regulator, Series ED07

2024-02-20

R414009647

Dimensions

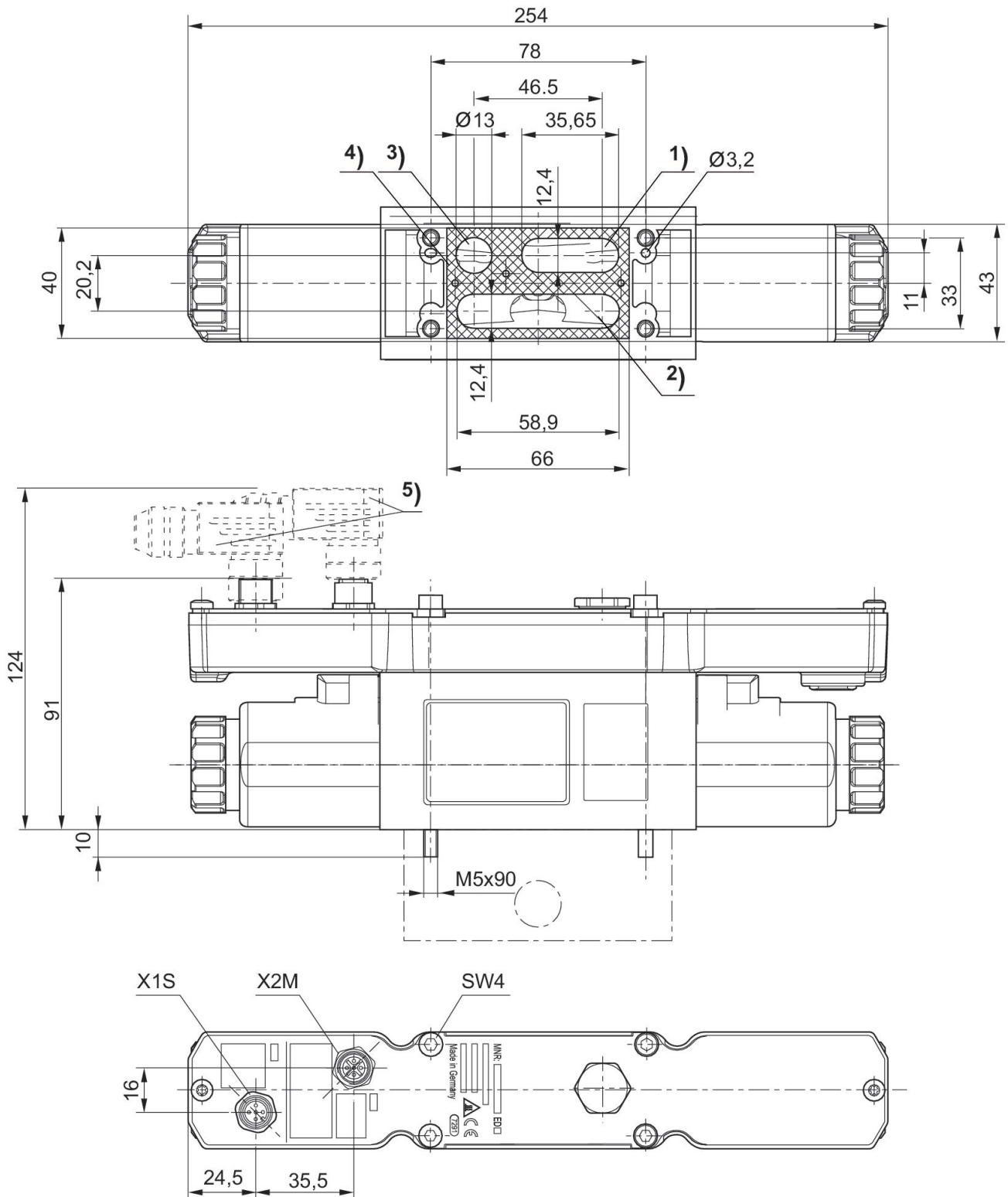

- 1) Operating pressure
- 2) Working pressure
- 3) Exhaust
- 4) Flat gasket
- 5) Accessories not supplied

R414009647

Flow diagram

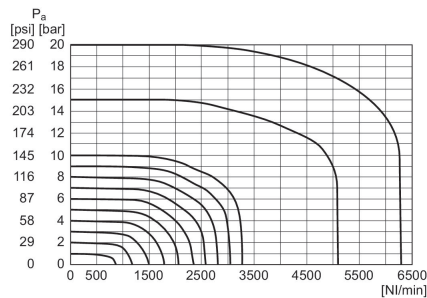

Pa = Working pressure

Fig. 3

Characteristic and pin assignment for potentiometer control without actual output value

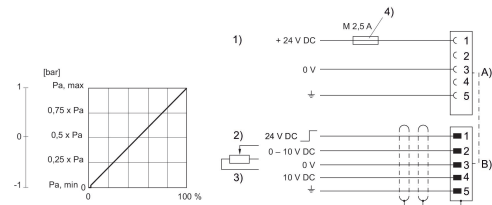

- 1) Supply Voltage
- 2) Switch output (pin 1) and nominal value (pin 2) are related to 0 V.
- 3) Potentiometer control (min. 0-2 kΩ, max. 0-10 kΩ)
- 4) The operating voltage must be protected by an external M 2.5 A fuse. Connect plug X2M via a shielded cable to ensure EMC. A) Plug X1S B) Plug X2M

Fig. 2

Characteristic and pin assignment for voltage control with actual output value

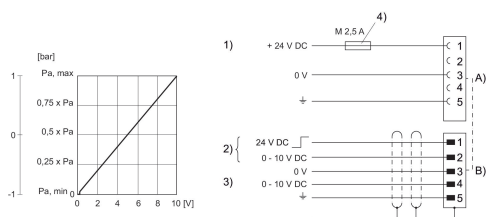

- 1) Supply Voltage
- 2) Switch output (pin 1) and nominal value (pin 2) are related to 0 V.
- 3) Actual value (pin 4) is related to 0 V (min. load resistance 1 kΩ).
- 4) The operating voltage must be protected by an external M 2.5 A fuse. Connect plug X2M via a shielded cable to ensure EMC. A) Plug X1S B) Plug X2M

Fig. 1

Characteristic and pin assignment for current control with actual output value

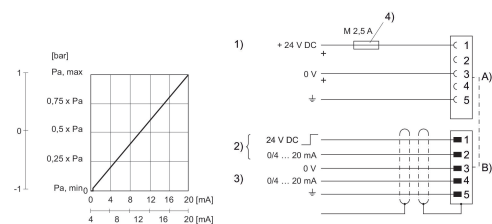

- 1) Supply Voltage
- 2) Switch output (pin 1) and nominal value (pin 2) are related to 0 V. Input current nominal value (ohmic load 100 Ω).
- 3) Actual value (pin 4) is related to 0 V (max. total resistance of downstream devices < 300 Ω).
- 4) The operating voltage must be protected by an external M 2.5 A fuse. Connect plug X2M via a shielded cable to ensure EMC. A) Plug X1S B) Plug X2M

Functional diagram

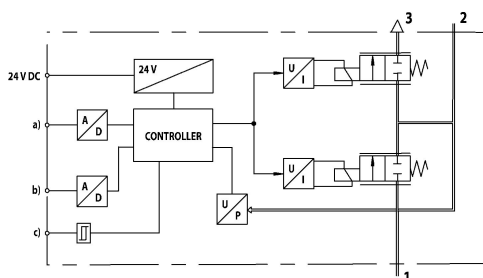

- a) Nominal input value b) Actual output value c) Switch output (acknowledge signal) The E/P pressure control valve modulates the pressure corresponding to an analog electrical nominal input value.
- 1) Operating pressure
 - 2) Working pressure
 - 3) Exhaust