

R414000687

## AVENTICS ED07 Dynamic Direct Acting Pressure Regulator

The AVENTICS Series ED07 offers proportional pressurization and the exhaust valves are controlled separately to deliver dynamic control for the most demanding applications.

Highly dynamic proportional pressure regulator

Stackable with base plate

Nominal width 7

Flow 1300 l/min

Pressure range -1 ... 20 bar

EtherCAT, AES fieldbus connection

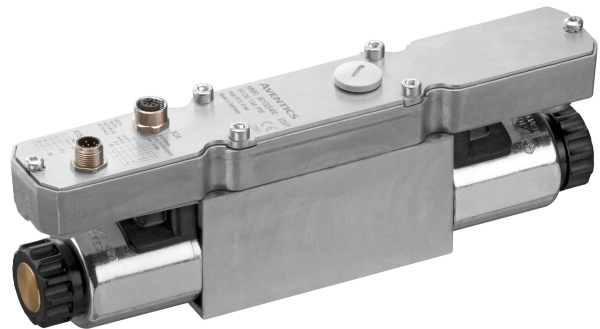

### Technical data

|                          |                         |
|--------------------------|-------------------------|
| Control                  | Directly controlled     |
| Control                  | Analog                  |
| Function                 | Air exhaust             |
| Actual output value      | Analog<br>Switch output |
| Min. regulation range    | -1 bar                  |
| Max. regulation range    | 1 bar                   |
| Min. working pressure    | 0.5 bar                 |
| Max. working pressure    | 3 bar                   |
| Hysteresis               | < 0,015 bar             |
| Medium                   | Compressed air          |
| Nominal flow Qn          | 1300 l/min              |
| Min. ambient temperature | 5 °C                    |
| Max. ambient temperature | 50 °C                   |
| Min. medium temperature  | 5 °C                    |
| Max. medium temperature  | 50 °C                   |
| Operational voltage DC   | 24 V                    |
| Max. current consumption | 1400 mA                 |
| Protection class         | IP65                    |
| Permissible ripple       | 5%                      |

# E/P pressure regulator, Series ED07

2024-02-20

R414000687

---

|                                       |  |
|---------------------------------------|--|
| Max. particle size                    | 50 µm  |
| Max. oil content of compressed air    | 1 mg/m <sup>3</sup>                                      |
| Type                                  | Poppet valve   |
| Mounting orientation                  | $\alpha = 0 \dots 90^\circ \pm \beta = 0 \dots 90^\circ$ |
| Certificates                          | CE declaration of conformity                             |
| Electrical connection type            | Plug   |
| Electrical connection size            | M12  |
| Electrical connection number of poles | 5-pin  |
| Signal connection                     | input and output   |
| Signal connection                     | Socket   |
| Signal connection                     | M12  |
| Signal connection                     | 5-pin  |
| Actual output value                   | 0 ... 20 mA  |
| Nominal input value                   | 0 ... 20 mA  |
| Industry                              | Industrial   |
| Weight                                | 2.05 kg  |

## Material

|                  |   |
|------------------|---|
| Housing material | Die-cast aluminum<br>Steel, chrome-plated   |
| Seal material    | Hydrogenated acrylonitrile butadiene rubber |
| Part No.         | R414000687                                  |

## Technical information

With oil-free, dry air, other installation positions are possible on request.

The protection class is only ensured when the plug is mounted properly. For detailed information, see operating instructions.

Minimum working pressure =  $[[0.5] \text{ bar}] + \text{max. required secondary pressure}$

Additional pressure setting ranges available on request

The min. control pressure must be adhered to, since otherwise faulty switching and valve failure may result!

The pressure dew point must be at least 15 °C less than ambient and medium temperature and may not exceed 3 °C.

The oil content of compressed air must remain constant during the life cycle.

Use only the approved oils from AVENTICS. Further information can be found in the "Technical information" document (available in <https://www.emerson.com/en-us/support>).

## Mounting orientation

$$\beta = \pm 0 \dots 90^\circ$$

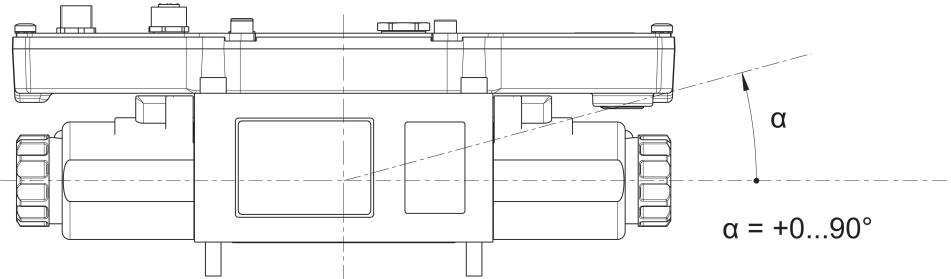
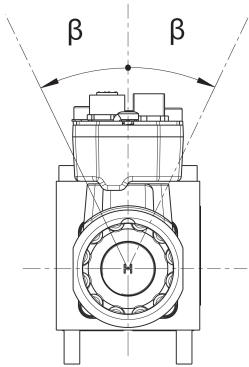

# E/P pressure regulator, Series ED07

2024-02-20

R414000687

## Dimensions

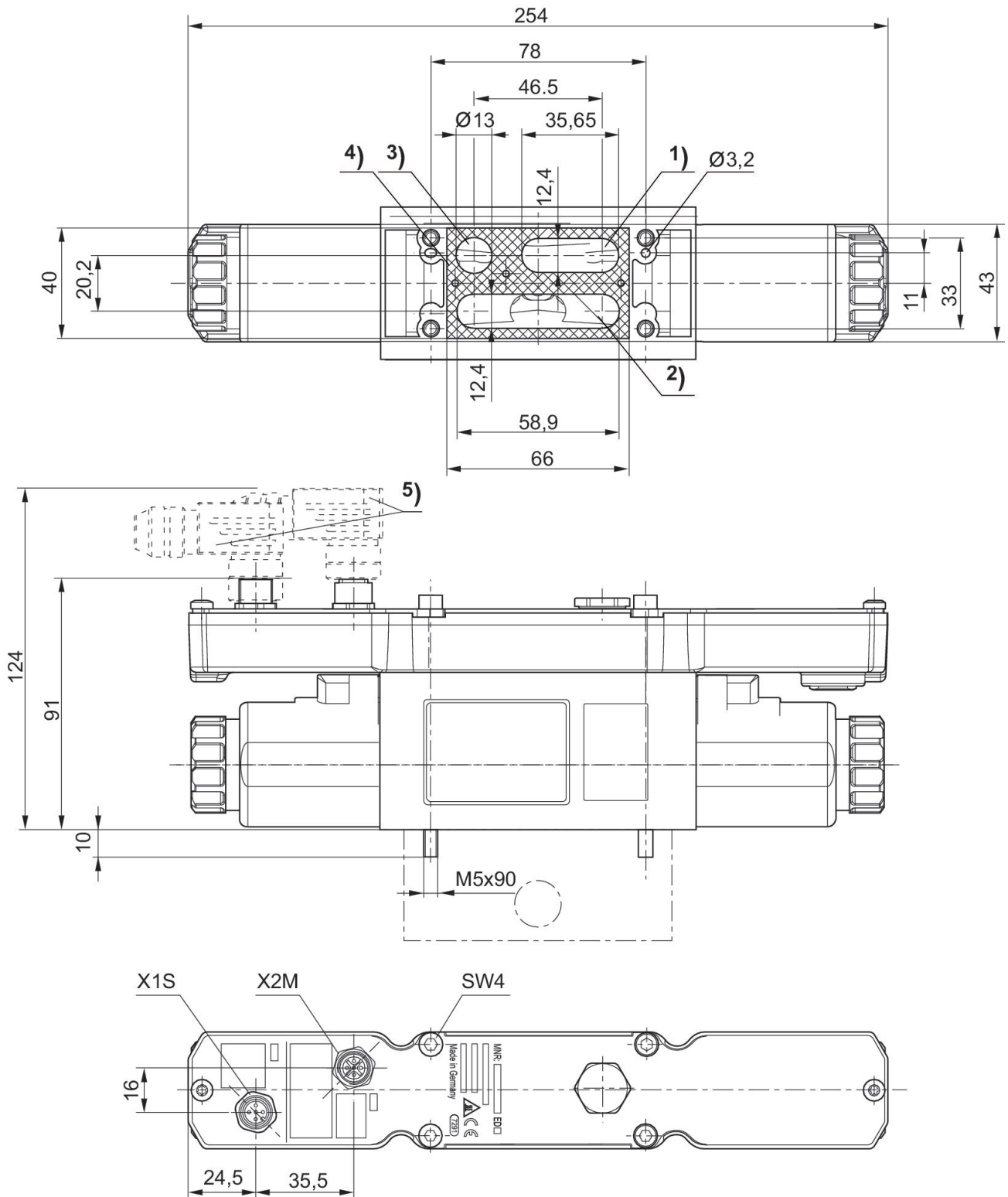

- 1) Operating pressure
- 2) Working pressure
- 3) Exhaust
- 4) Flat gasket
- 5) Accessories not supplied

R414000687

## Flow diagram

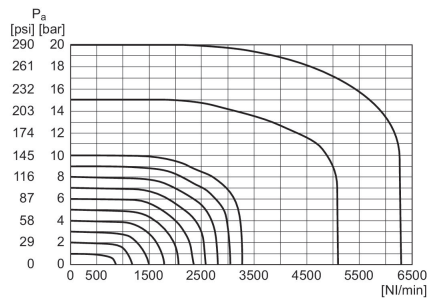

Pa = Working pressure

Fig. 3

Characteristic and pin assignment for potentiometer control without actual output value

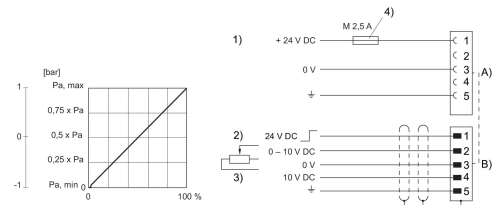

- 1) Supply Voltage
- 2) Switch output (pin 1) and nominal value (pin 2) are related to 0 V.
- 3) Potentiometer control (min. 0-2 kΩ, max. 0-10 kΩ)
- 4) The operating voltage must be protected by an external M 2.5 A fuse. Connect plug X2M via a shielded cable to ensure EMC. A) Plug X1S B) Plug X2M

Fig. 2

Characteristic and pin assignment for voltage control with actual output value

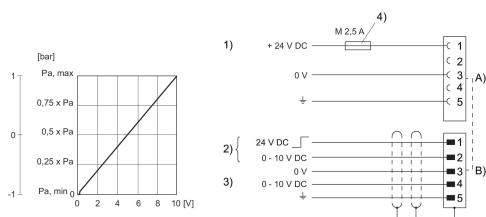

- 1) Supply Voltage
- 2) Switch output (pin 1) and nominal value (pin 2) are related to 0 V.
- 3) Actual value (pin 4) is related to 0 V (min. load resistance 1 kΩ).
- 4) The operating voltage must be protected by an external M 2.5 A fuse. Connect plug X2M via a shielded cable to ensure EMC. A) Plug X1S B) Plug X2M

Fig. 1

Characteristic and pin assignment for current control with actual output value

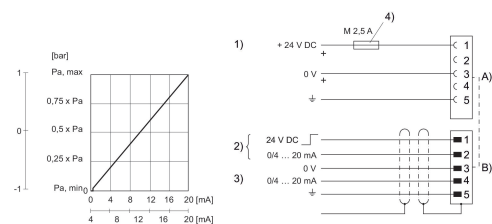

- 1) Supply Voltage
- 2) Switch output (pin 1) and nominal value (pin 2) are related to 0 V. Input current nominal value (ohmic load 100 Ω).
- 3) Actual value (pin 4) is related to 0 V (max. total resistance of downstream devices < 300 Ω).
- 4) The operating voltage must be protected by an external M 2.5 A fuse. Connect plug X2M via a shielded cable to ensure EMC. A) Plug X1S B) Plug X2M

## Functional diagram

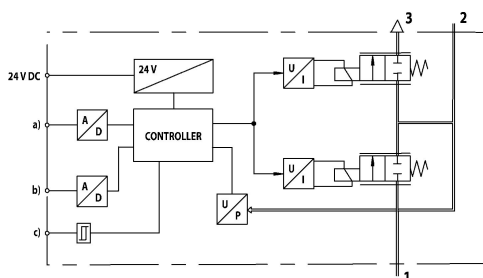

a) Nominal input value b) Actual output value c) Switch output (acknowledge signal) The E/P pressure control valve modulates the pressure corresponding to an analog electrical nominal input value.

- 1) Operating pressure
- 2) Working pressure
- 3) Exhaust