

# ED12 series proportional pressure regulator

## R414009672

General series information  
AVENTICS ED12 Dynamic Direct Acting  
Pressure Regulator

- The AVENTICS ED12 direct acting pressure regulator offers proportional pressurization and the exhaust valves are controlled separately to deliver dynamic control for the most demanding applications.

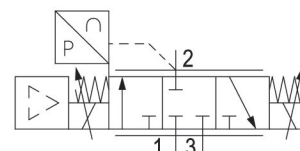

### Technical data

Control	Directly controlled
Control	Analog
Function	Air exhaust
Actual output value	constant voltage Switch output
Regulation range min.	0 bar
Regulation range max.	2 bar
Working pressure min.	0.5 bar
Working pressure max.	3 bar
Hysteresis	< 0,015 bar
Medium	Compressed air
Nominal flow Qn	2600 l/min
Min. ambient temperature	5 °C
Max. ambient temperature	50 °C
Min. medium temperature	5 °C
Max. medium temperature	50 °C
DC operating voltage	24 V
Max. current consumption	1400 mA
Protection class	IP65
Permissible ripple	5%
Max. particle size	50 µm
Oil content of compressed air min.	0 mg/m <sup>3</sup>
Oil content of compressed air max.	1 mg/m <sup>3</sup>
Type	Poppet valve
Mounting orientation	$\alpha = 0 \dots 90^\circ \pm \beta = 0 \dots 90^\circ$
Certificates	CE declaration of conformity
Electrical connection type	Plug

Electrical connection size	M12
Electrical connection number of poles	5-pin
Signal connection	input and output
Signal connection	Socket
Signal connection	M12
Signal connection	5-pin
Nominal input value	0 ... 10 V
Industry	Industrial
Weight	2.3 kg

## Material

Housing material	Aluminum Steel, chrome-plated
Seal material	Hydrogenated acrylonitrile butadiene rubber
Part No.	R414009672

## Technical information

With oil-free, dry air, other installation positions are possible on request.

Nominal flow  $Q_n$  with working pressure 7 bar, with secondary pressure 6 bar and  $\Delta p = 0.2$  bar

The protection class is only ensured when the plug is mounted properly. For detailed information, see operating instructions.

The min. control pressure must be adhered to, since otherwise faulty switching and valve failure may result!

The pressure dew point must be at least 15 °C less than ambient and medium temperature and may not exceed 3 °C.

The oil content of compressed air must remain constant during the life cycle.

Use only the approved oils from AVENTICS. Further information can be found in the "Technical information" document (available in <https://www.emerson.com/en-us/support>).

## Mounting orientation

$$\beta = \pm 0 \dots 90^\circ$$

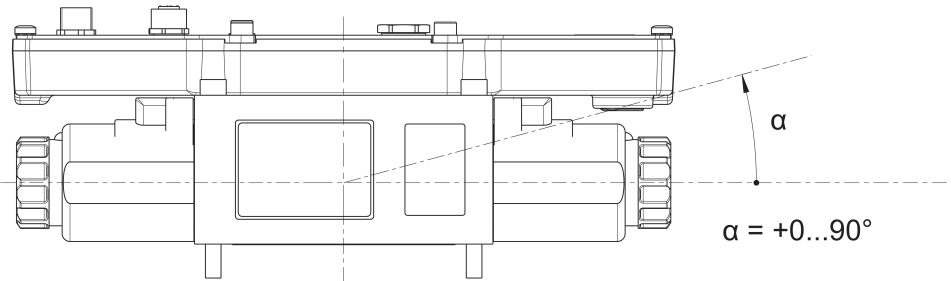
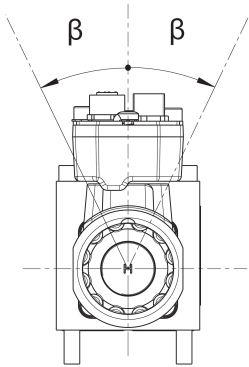

## Dimensions

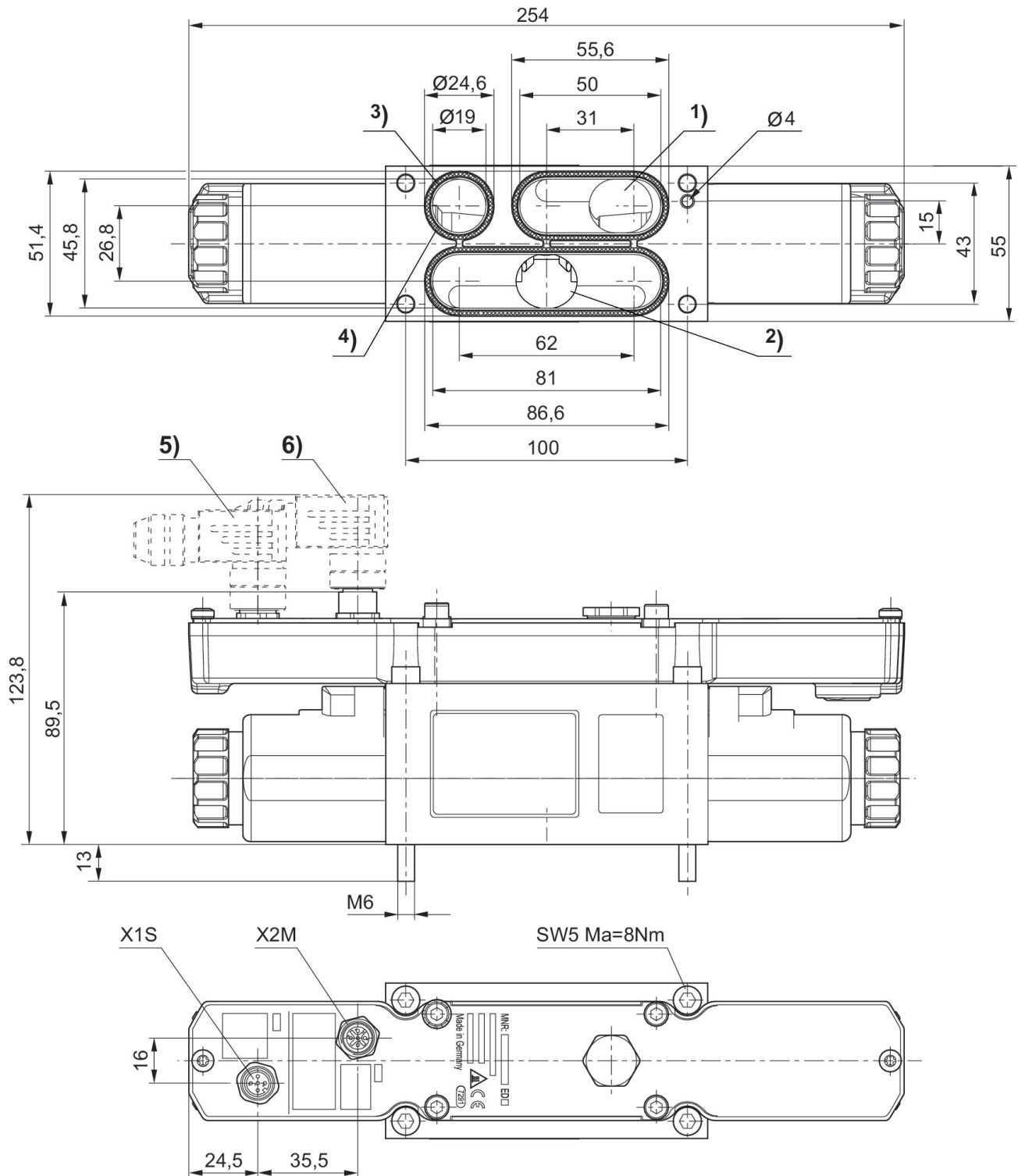

1) Operating pressure 2) Working pressure 3) Exhaust 4) Seal (not assembled) 5) + 6) Accessories not supplied

## Flow diagram

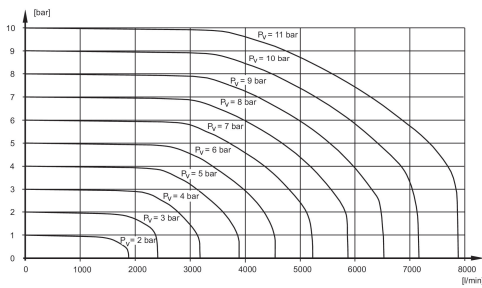

Pv = Supply pressure

**Fig. 2**  
Characteristic and pin assignment for voltage control with actual output value

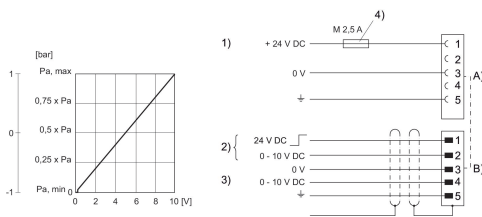

- 1) Supply Voltage
- 2) Switch output (pin 1) and nominal value (pin 2) are related to 0 V.
- 3) Actual value (pin 4) is related to 0 V (min. load resistance 1 kΩ).
- 4) The operating voltage must be protected by an external M 2.5 A fuse. Connect plug X2M via a shielded cable to ensure EMC. A) Plug X1S B) Plug X2M

**Fig. 3**  
Characteristic and pin assignment for potentiometer control without actual output value

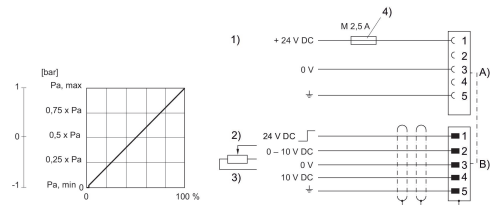

- 1) Supply Voltage
- 2) Switch output (pin 1) and nominal value (pin 2) are related to 0 V.
- 3) Potentiometer control (min. 0-2 kΩ, max. 0-10 kΩ)
- 4) The operating voltage must be protected by an external M 2.5 A fuse. Connect plug X2M via a shielded cable to ensure EMC. A) Plug X1S B) Plug X2M

**Fig. 1**  
Characteristic and pin assignment for current control with actual output value

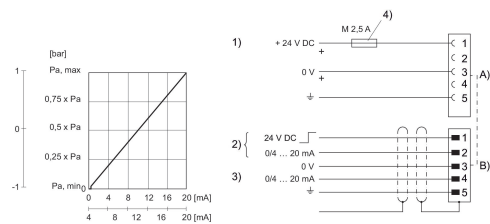

- 1) Supply Voltage
- 2) Switch output (pin 1) and nominal value (pin 2) are related to 0 V. Input current nominal value (ohmic load 100 Ω).
- 3) Actual value (pin 4) is related to 0 V (max. total resistance of downstream devices < 300 Ω).
- 4) The operating voltage must be protected by an external M 2.5 A fuse. Connect plug X2M via a shielded cable to ensure EMC. A) Plug X1S B) Plug X2M

## Functional diagram

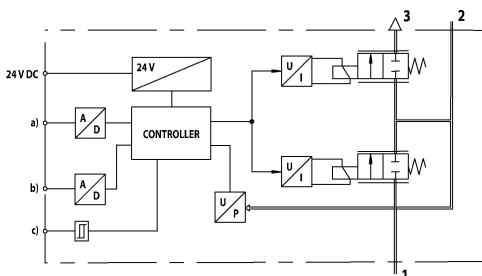

- a) Nominal input value b) Actual output value c) Switch output (acknowledge signal) The E/P pressure control valve modulates the pressure corresponding to an analog electrical nominal input value.
- 1) Operating pressure
  - 2) Working pressure
  - 3) Exhaust