

E/P pressure regulator, Series EV07

5610102170

Series EV07

- Piloted pressure regulator
- Flow [[800] l/min]

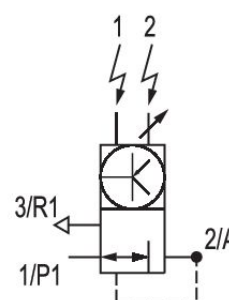
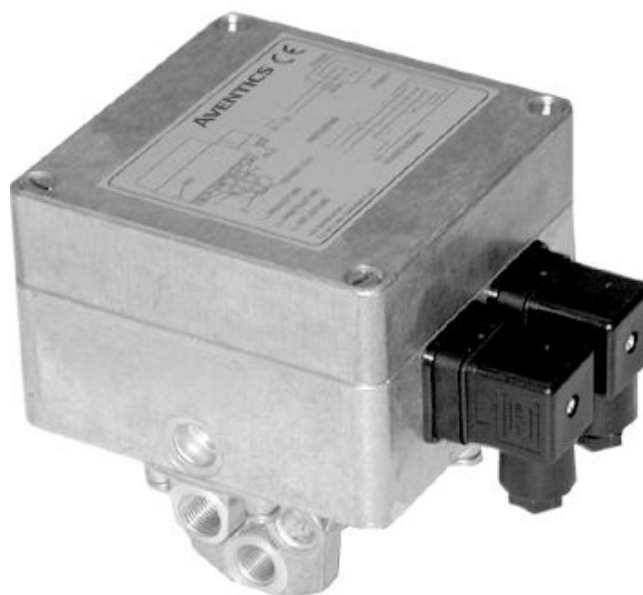

Technical data

Control

Analog

Regulation range min.

0.15 bar

Regulation range max.

10 bar

Working pressure min.

0.5 bar

Working pressure max.

11 bar

Hysteresis

[[0,04] bar]

Medium

Compressed air

Nominal flow Q_n

800 l/min

Min. ambient temperature

5 °C

Max. ambient temperature

50 °C

Min. medium temperature

5 °C

Max. medium temperature

50 °C

DC operating voltage

24 V

Permissible ripple

5%

Max. power consumption 200 mA	Compressed air connection, exhaust G 1/4
Protection class IP54	Electrical connection type Plug
Max. particle size 50 µm	Electrical connection size EN 175301-803, form A
Oil content of compressed air min. 0 mg/m ³	Signal connection input and output
Oil content of compressed air max. 0.1 mg/m ³	Signal connection Plug
Type Poppet valve	Signal connection EN 175301-803, form A
Mounting orientation vertical	Actual output value 4 ... 20 mA
Certificates CE declaration of conformity	Nominal input value 4 ... 20 mA
Compressed air connection input G 1/4	Industry Industrial
Compressed air connection output G 1/4	Weight 2 kg

Material

Housing material
Die-cast aluminum

Part No.
5610102170

Seal material
Acrylonitrile butadiene rubber

Technical information

The protection class is only ensured when the plug is mounted properly. For detailed information, see operating instructions.

The min. control pressure must be adhered to, since otherwise faulty switching and valve failure may result!

The pressure dew point must be at least 15 °C under ambient and medium temperature and may not exceed 3 °C .

The oil content of compressed air must remain constant during the life cycle.

Use only the approved oils from AVENTICS. Further information can be found in the "Technical information" document (available in <https://www.emerson.com/en-us/support>).

Dimensions

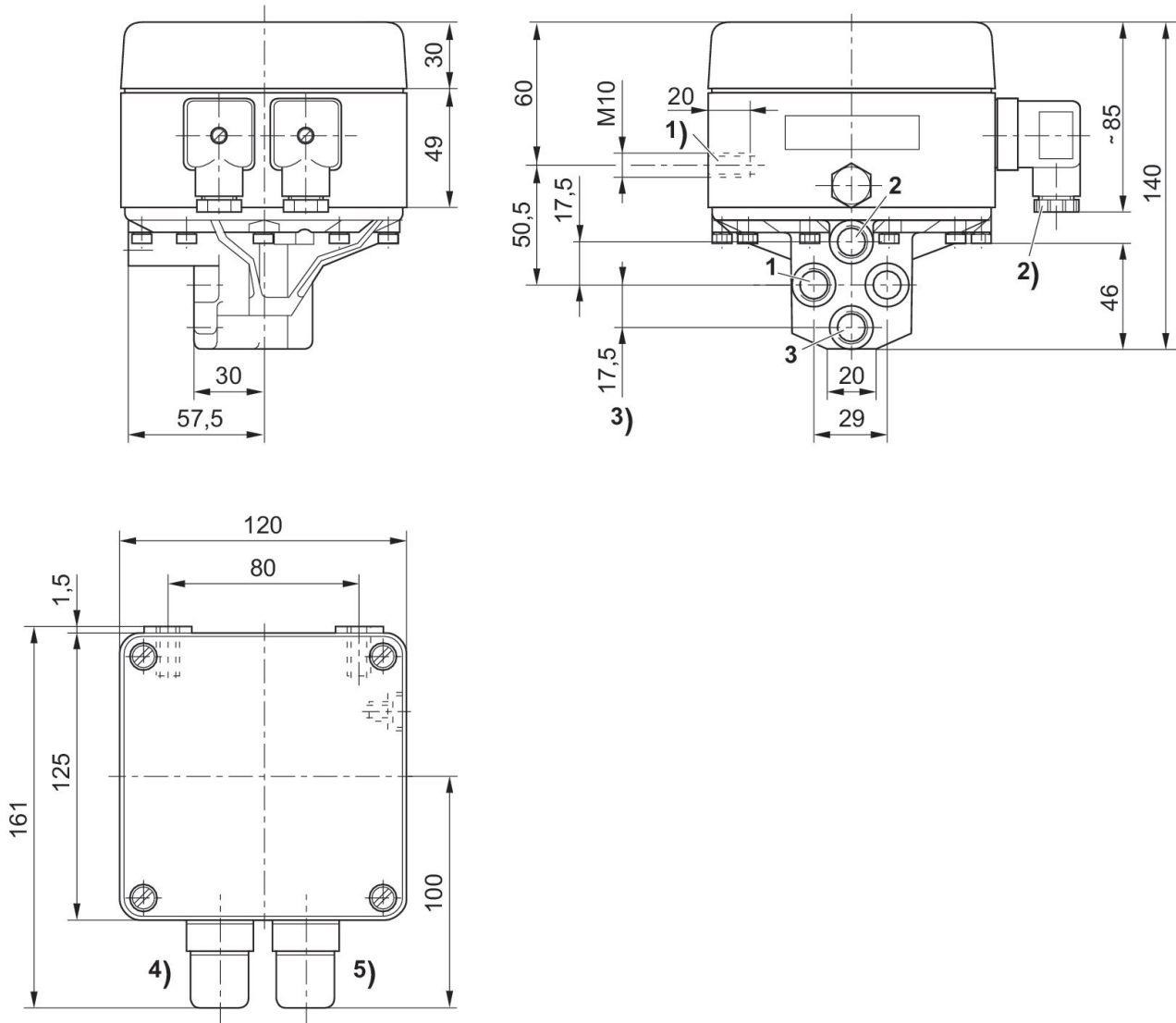

1) mounting thread 2) PG 9 3) threaded connection 1 - 3 = G1/4 ISO 228/1:2000 4) plug 1 5) plug 2

Fig. 3
Characteristic and pin assignment for potentiometer control without actual output value

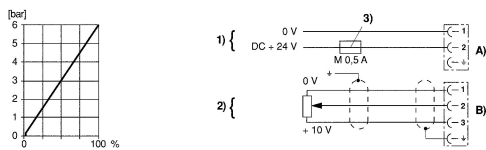

1) Supply voltage 2) Potentiometer control (0 - 2 kΩ (min.), 0 - 10 kΩ (max.))
3) The supply voltage must be protected by an external M 0.5 A fuse.
Connect plug 2 via a shielded cable to ensure EMC. A) Plug 1 B) Plug 2

Fig. 2
Characteristic and pin assignment for voltage control with actual output value

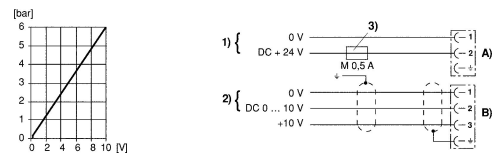

1) Supply voltage 2) Voltage control 3) The supply voltage must be protected by an external M 0.5 A fuse. Connect plug 2 via a shielded cable to ensure EMC. A) Plug 1 B) Plug 2

Fig. 1
Characteristic and pin assignment for current control with actual output value

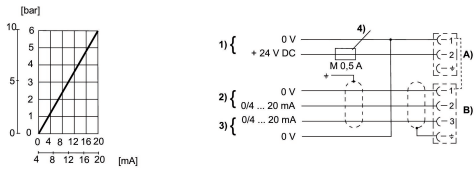

1) Supply voltage 2) Input current nominal value (ohmic load 100 Ω , max. 50 mA). The (+) and (-) connection potential must be in the range 0-12 V related to plug 1, pin 1. 3) Actual output value (max. total resistance of downstream devices < 300 Ω) The actual value is measured between plug 2, pin 3 and plug 1, pin 1. The actual value is short circuit resistant for a limited time. 4) The supply voltage must be protected by an external M 0.5 A fuse. Connect plug 2 via a shielded cable to ensure EMC. A) Plug 1 B) Plug 2

Functional diagram

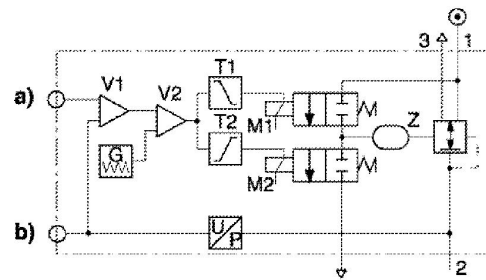

a) Nominal input value b) Actual output value The E/P pressure control valve modulates the pressure corresponding to an analog electrical nominal input value. The integrated electronics make a comparison between the nominal input value and the pressure in the output line (actual value). The controller generates electrical input signals, which either ventilate or exhaust control volume Z of the relay valve by means of two pilot valves (M1, M2) until the specified pressure is attained in the output line.

- 1) Operating pressure
- 2) Working pressure
- 3) Exhaust