

E/P pressure regulator, Series EV12

R414011398

General series information Series EV12

- The AVENTICS EV12 high flow proportional pressure control valve with its compact design hides its large flow capacity. It can be used as a stand-alone solution (high flow valve), as a battery for block assembly with consistently controlled pressure, or integrated into a maintenance unit.

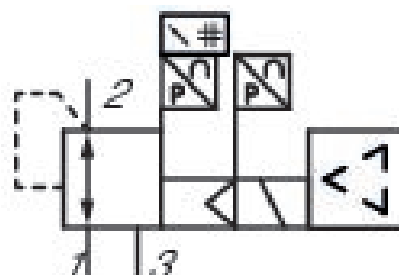

Technical data

Type	Pressure supply, right
Control	Display: display
Air supply	Externally piloted
Regulation range min.	right
Regulation range max.	0 bar
Hysteresis	10 bar
Medium	0,12 bar
Nominal flow Qn	Neutral gases
Min. ambient temperature	6500 l/min
Max. ambient temperature	0 °C
Min. medium temperature	50 °C
	0 °C

Max. medium temperature	50 °C
DC operating voltage	24 V
Permissible ripple	5%
Max. current consumption	220 mA
Max. particle size	50 µm
Oil content of compressed air min.	0 mg/m ³
Oil content of compressed air max.	5 mg/m ³
Frame size	AS3
Type	Poppet valve
Compressed air connection input	G 3/8
Compressed air connection output	G 3/8
Electrical connection size	M12
Electrical connection number of poles	5-pin
Electrical connection coding	A-coded
Actual output value	0 ... 10 V
Nominal input value	0 ... 10 V
Industry	Industrial
Weight	1.4 kg

Material

Housing material	Polyamide
Seal material	Nitrile butadiene rubber
Material base plate	Aluminum
Part No.	R414011398

Technical information

Power outage: maintain pressure

The min. control pressure must be adhered to, since otherwise faulty switching and valve failure may result!

The pressure dew point must be at least 15 °C less than ambient and medium temperature and may not exceed 3 °C.

The oil content of compressed air must remain constant during the life cycle.

Use only the approved oils from AVENTICS. Further information can be found in the "Technical information" document (available in <https://www.emerson.com/en-us/support>).

Dimensions

Pressure supply, right

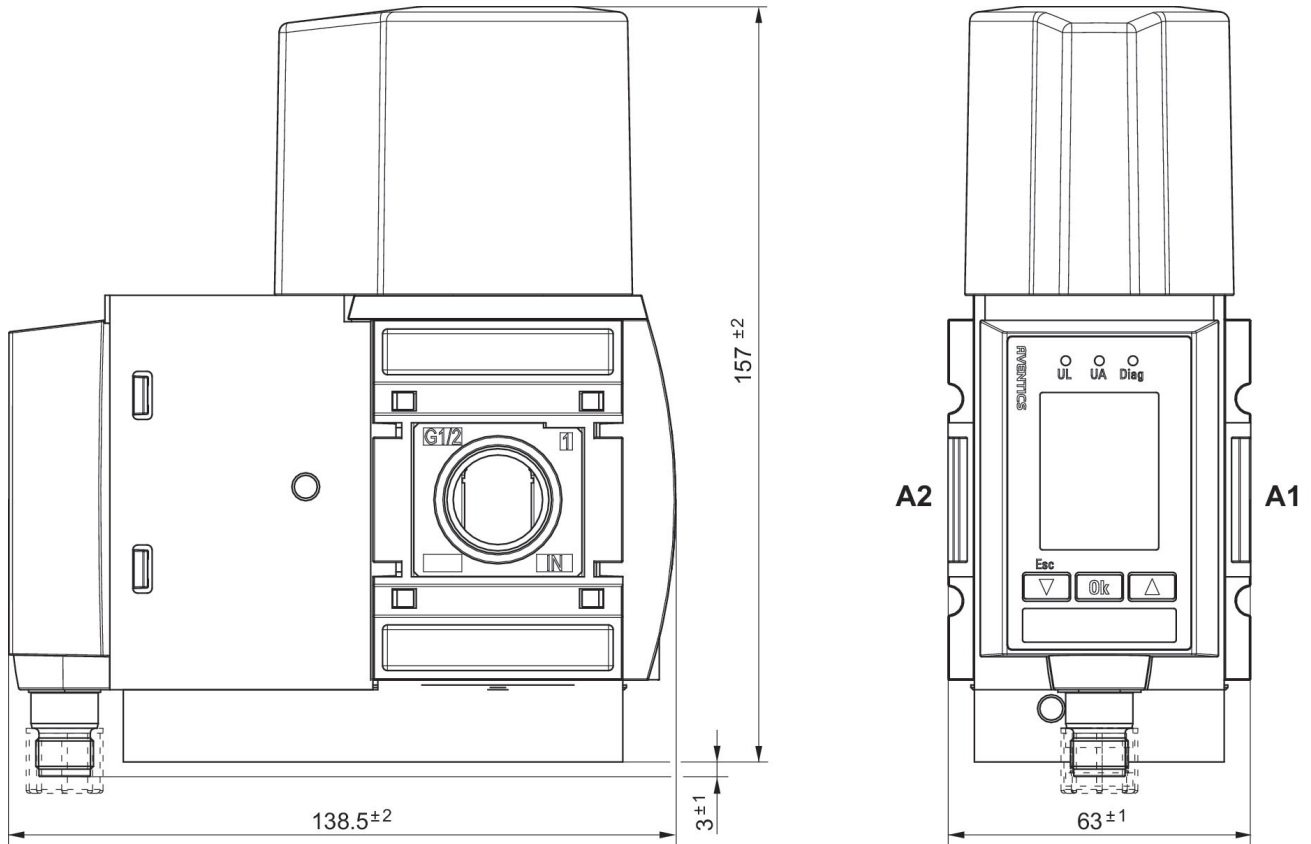

A1 = input
A2 = output

Pressure supply, right

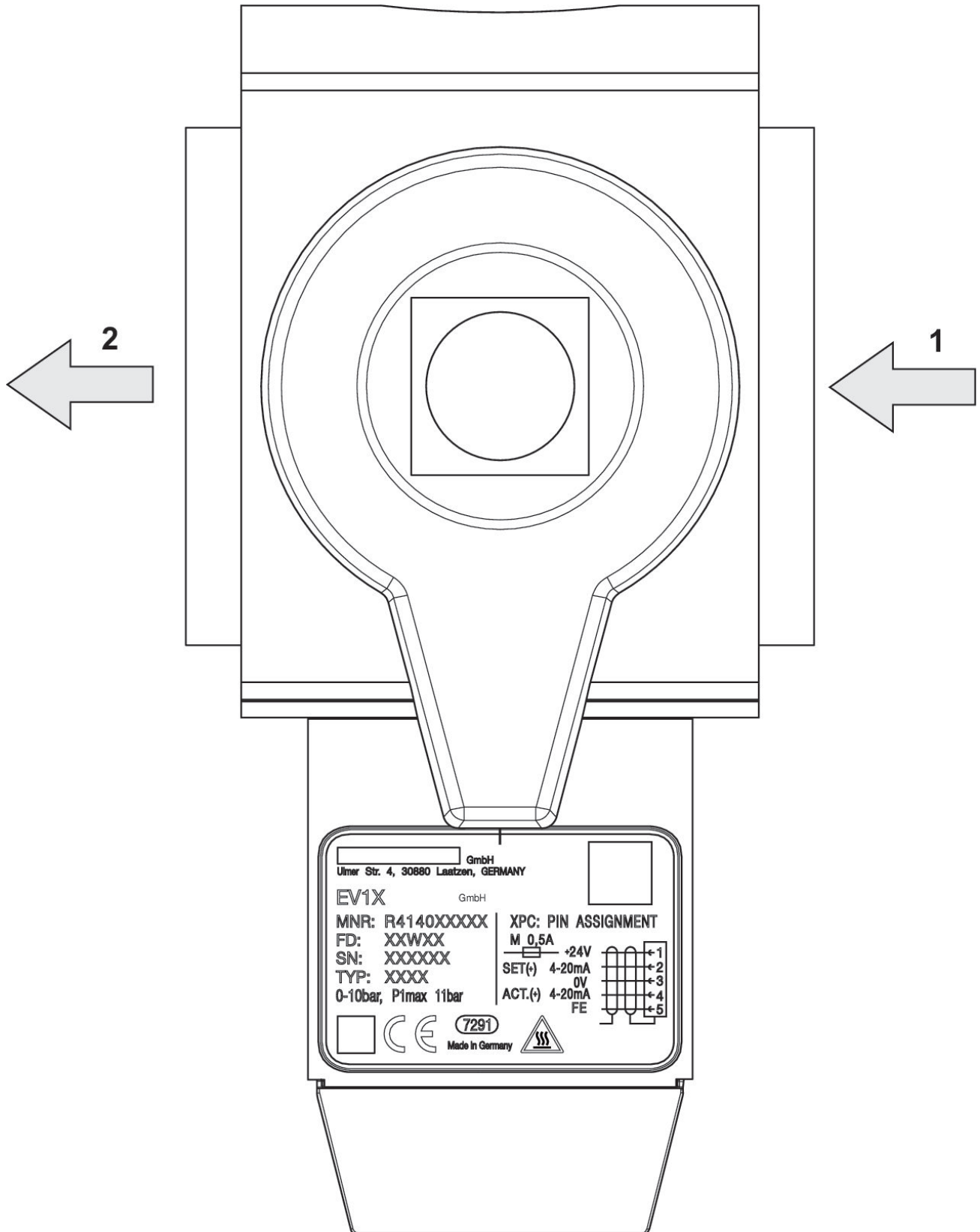

Flow characteristic curve

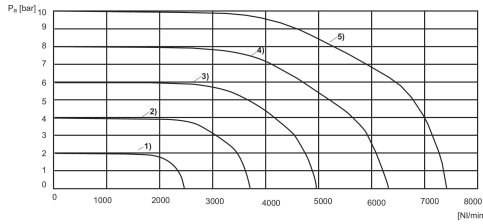

1) $P_v = [[3] \text{ bar}]$ 2) $P_v = [[5] \text{ bar}]$ 3) $P_v = [[7] \text{ bar}]$ 4) $P_v = [[9] \text{ bar}]$ 5) $P_v = [[11] \text{ bar}]$

P_v = Supply pressure
 P_a = Working pressure
 $P_v = P_a + 1$

Characteristic curve and plug assignment for IO-Link version

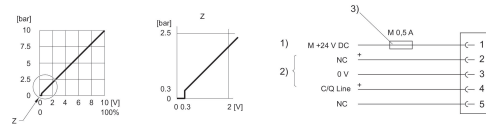

- 1) power supply
- 2) C/Q Line (pin 4) Not connected (NC) (pin 2) are related to 0 V (pin 3).
- 3) The power supply must be protected by an external M 0.5 A fuse. Connect the plug via a shielded cable to ensure EMC.

Characteristic and pin assignment for voltage control with actual output value

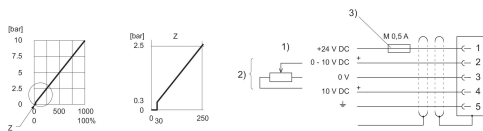

- 1) power supply
- 2) Actual value (pin 4) and nominal value (pin 2) are related to 0 V (pin 3). Nominal input value ($R = 1 \text{ M}\Omega$), actual output value: min. load resistance $> 10 \text{ K}\Omega$. If the power supply is switched off, the nominal input value is high-ohmic.
- 3) The power supply must be protected by an external M 0.5 A fuse. Connect the plug via a shielded cable to ensure EMC.

Characteristic and pin assignment for current control with actual output value

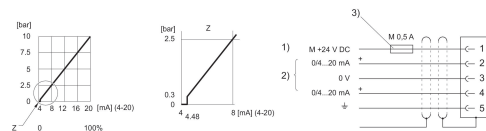

- 1) power supply
- 2) Actual value (pin 4) and nominal value (pin 2) are related to 0 V (pin 3). Nominal input value (ohmic load 100Ω), actual output value: external ohmic load $< 300 \Omega$. If the power supply is switched off, the nominal input value is high-ohmic.
- 3) The power supply must be protected by an external M 0.5 A fuse. Connect the plug via a shielded cable to ensure EMC.

Functional diagram IO-Link

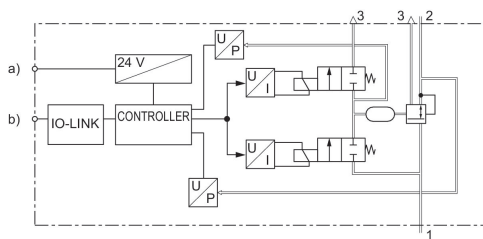

a) Supply Voltage
b) C/Q Line

Functional diagram

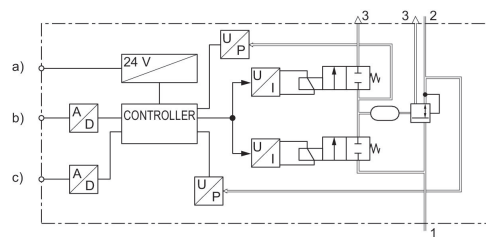

a) Voltage supply b) Nominal value
c) Actual output value

Plug assignment

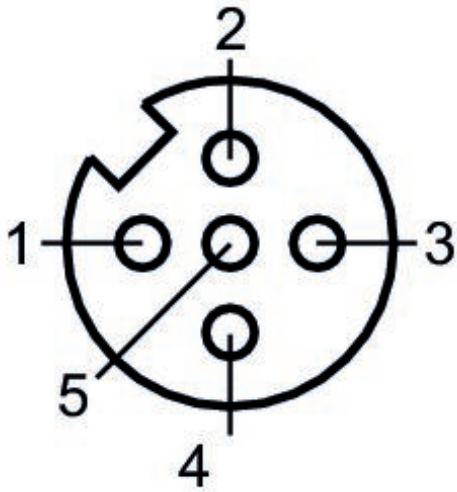

-
- 1) 24 V DC
 - 2) Nominal input value
 - 3) GND
 - 4) Actual output value
 - 5) Ground