

AVENTICS Foot mountings



Technical data

Industry

Industrial

Version

Archive product: Do not use in new constructions!

Frame size

RAK - 3S

Material

Material

Steel, chrome-plated

Surface

galvanized

Part No.

2706132000

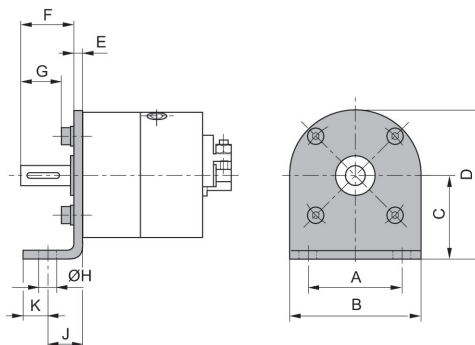

Foot mounting

2706132000

Foot
mountings

2024-09-25

For series	Part No.	A	B	C	D	E	F	G	H
RAK - 1S	2706112000	20	30	22	37	2	14	10.3	4.8
RAK - 2S	2706122000	26	36	25	43	2.6	16.4	12.7	4.8
RAK - 3S	2706132000	30	42	30	51	3.2	19.8	16.1	5.8
RAK - 4S	2706142000	36	49	34	58	3.6	25	18.7	6.5
RAK - 5S, RAK - 5D	2706152000	48	66	42	75	4.5	27	20.7	6.5

For series	J	K
RAK - 1S	10	5
RAK - 2S	11	7
RAK - 3S	12	8
RAK - 4S	15	10
RAK - 5S, RAK - 5D	18	12