

Double nipple, detachable, tapered

2024-03-21

1823391256

AVENTICS Blanking screws and connectors

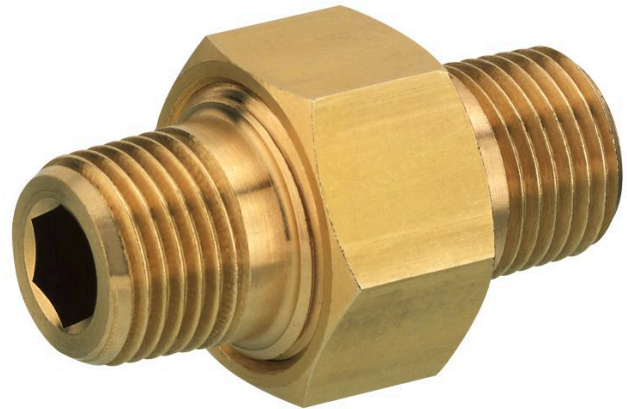

Technical data

Industry	Industrial
Port G	R 1/2
Type	FPT-S-RDO
Min. working pressure	0 bar
Max. working pressure	16 bar
Min. ambient temperature	-20 °C
Max. ambient temperature	80 °C
Delivery unit	5 piece

Material

Material	Brass
Part No.	1823391256

Double nipple, detachable, tapered

2024-03-21

1823391256

Dimensions

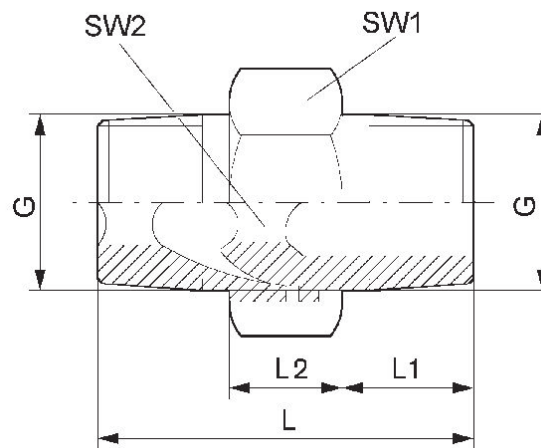

Part No.	Port G	L	L1	L2	SW1	SW2
1823391253	R 1/8	27	9.2	8.5	15	5
1823391254	R 1/4	33.5	12	9.5	19	6
1823391255	R 3/8	36.5	13	10	22	8
1823391256	R 1/2	44	16	12	27	12
1823391257	R 3/4	52.5	18	17	36	14
1823391258	R 1	63.5	22	20	46	19