

AVENTICS Blanking screws and connectors



Technical data

Industry	Industrial
Compressed air connection type	External thread
Port G	G 1/8
Compressed air connection type 2	Internal thread
Port D	G 1/4
Type	FPT-S-REN
Min. working pressure	0 bar
Max. working pressure	16 bar
Min. ambient temperature	-20 °C
Max. ambient temperature	80 °C
Delivery unit	10 piece
Weight	0.02 kg

Material

Material	Brass
Surface	nickel-plated
Seal material	Polyvinyl chloride
Part No.	2122918140

Dimensions

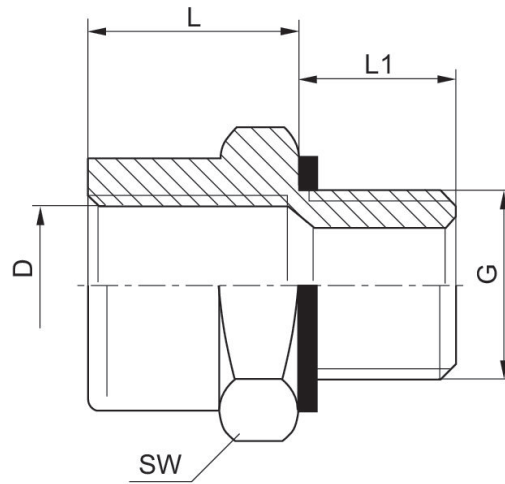

Part No.	Port D	Port G	L	L1	SW
8633051800	G 1/8	M5	14	4	14
2122918140	G 1/4	G 1/8	13,5	6	17
2122914380	G 3/8	G 1/4	14,5	8	22
8633141200	G 1/2	G 1/4	18	8	24
2122938120	G 1/2	G 3/8	27	9	26