

# Fine setting valve

3610507300

Fine setting  
valves

2024-03-14

## AVENTICS Fine setting valves

Fine-Setting-Valve: Manually operated pressure regulators with multiple manual actuating element choice.



## Technical data

Industry	Industrial
Type	Poppet valve
Actuating element	Push button
Compressed air connection input	G 1/4
Compressed air connection type input	Internal thread
Compressed air connection output	G 1/4
Min. working pressure	0.1 bar
Max. working pressure	10 bar
Min. regulation range	0.1 bar
Max. regulation range	4.1 bar
Min. ambient temperature	-25 °C
Max. ambient temperature	70 °C
Min. medium temperature	-25 °C
Max. medium temperature	70 °C
Medium	Compressed air
Nominal flow Qn	900 l/min
Hysteresis	< 0,15 bar
control stroke	7.5 mm
Min. actuating force	160 N
Parallel pressure displacement	1.4 bar
Weight	0.5 kg
Housing material	Die cast zinc

# Fine setting valve

3610507300

Fine setting  
valves

2024-03-14

---

Seal material	Acrylonitrile butadiene rubber
Part No.	3610507300

## Technical information

The min. control pressure must be adhered to, since otherwise faulty switching and valve failure may result!

The pressure dew point must be at least 15 °C less than ambient and medium temperature and may not exceed 3 °C.

The oil content of compressed air must remain constant during the life cycle.

Use only the approved oils from AVENTICS. Further information can be found in the "Technical information" document (available in <https://www.emerson.com/en-us/support>).

# Fine setting valve

3610507300

Fine setting  
valves

2024-03-14

## Dimensions

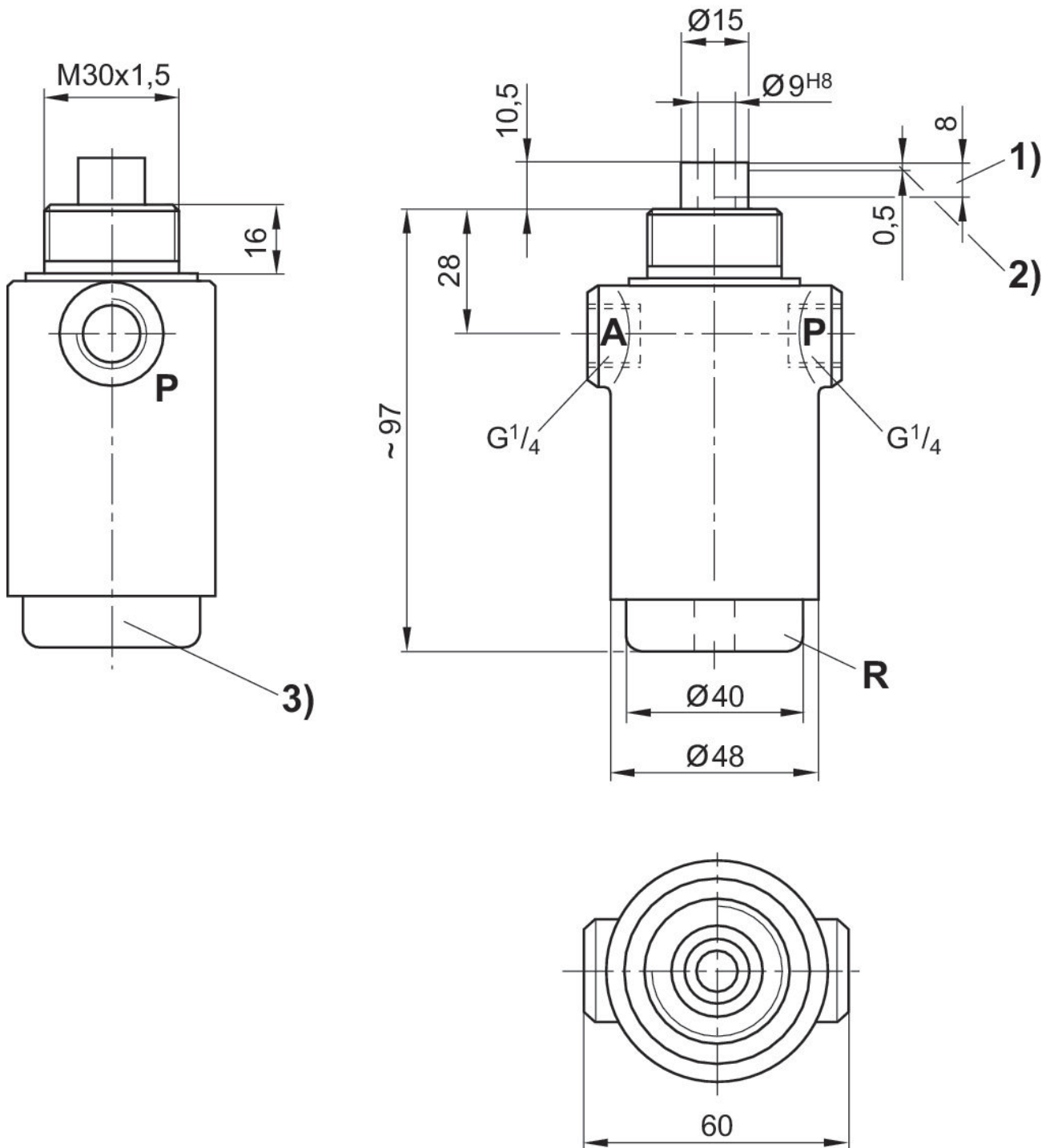

1) Stroke 2) Closing or exhaust stroke 3) Screw cap

A = connection output

P = connection input

R = Port exhaust

# Fine setting valve

3610507300

Fine setting  
valves

2024-03-14

## Pressure characteristics curve

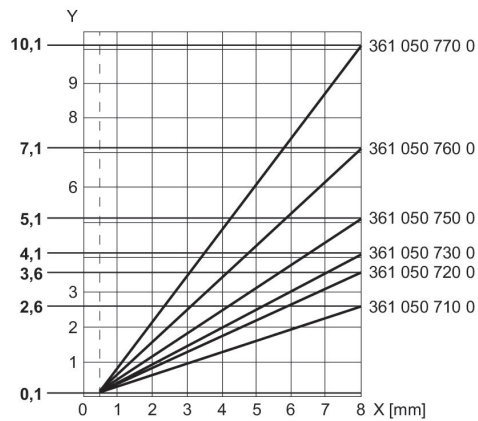

x = stroke

The characteristic curve can be moved parallel to the illustrated characteristic curve (in the y direction) using the screw cap.

## Flow rate characteristic, $p_2 = 0,05 - 7$ bar

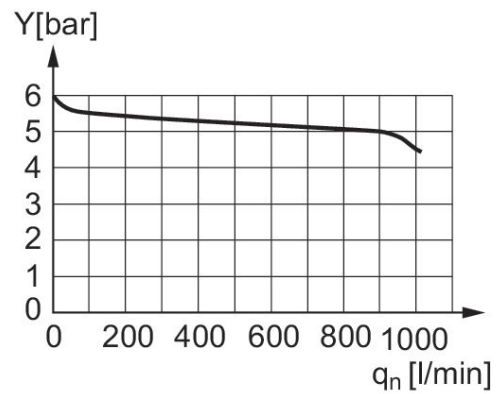

input pressure: 8 bar, supply pressure: 6 bar y: pressure in line "A" [bar]