

Fine setting valve

3610607600

Fine setting
valves

2024-03-14

AVENTICS Fine setting valves

Fine-Setting-Valve: Manually operated pressure regulators with multiple manual actuating element choice.



Technical data

Industry	Industrial
Type	Poppet valve
Actuating element	handwheel
Compressed air connection input	G 1/4
Compressed air connection type input	Internal thread
Compressed air connection output	G 1/4
Min. working pressure	0.1 bar
Max. working pressure	10 bar
Min. regulation range	0.1 bar
Max. regulation range	7.1 bar
Min. ambient temperature	-25 °C
Max. ambient temperature	70 °C
Min. medium temperature	-25 °C
Max. medium temperature	70 °C
Medium	Compressed air
Nominal flow Q _n	900 l/min
Hysteresis	< 0,15 bar
Parallel pressure displacement	0.8 bar
Weight	0.6 kg

Fine setting valve

3610607600

Fine setting
valves

2024-03-14

Housing material	Die cast zinc
Seal material	Acrylonitrile butadiene rubber
Part No.	3610607600

Technical information

The min. control pressure must be adhered to, since otherwise faulty switching and valve failure may result!

The pressure dew point must be at least 15 °C less than ambient and medium temperature and may not exceed 3 °C.

The oil content of compressed air must remain constant during the life cycle.

Use only the approved oils from AVENTICS. Further information can be found in the "Technical information" document (available in <https://www.emerson.com/en-us/support>).

Fine setting valve

3610607600

Fine setting
valves

2024-03-14

Dimensions

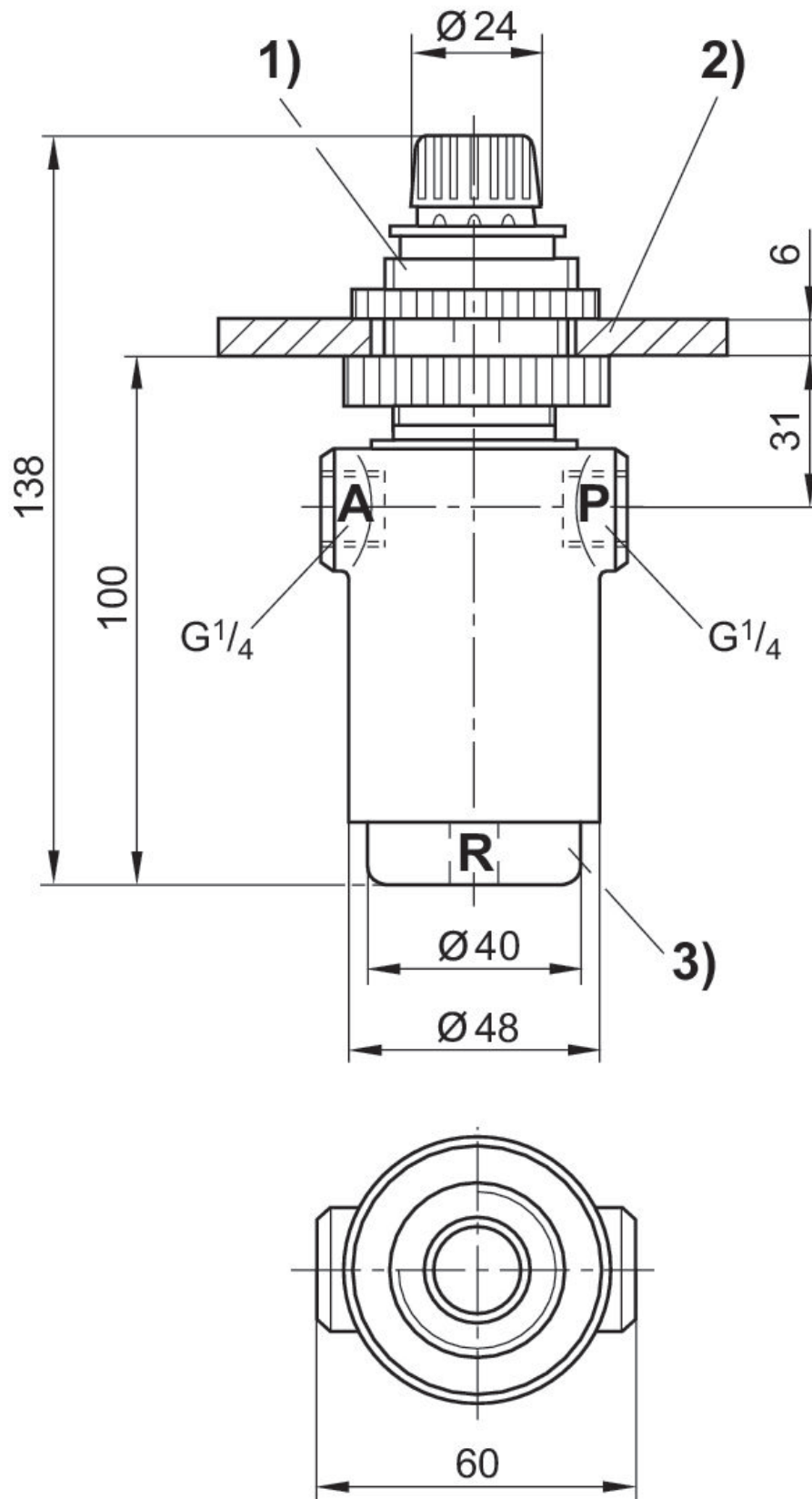

1) The handwheel can be adjusted once the locking ring has been pulled up. 2) hole for mounting plate \varnothing 31 mm 3) screw cap
A = connection output

Fine setting valve

3610607600

Fine setting valves

2024-03-14

P = connection input
R = Port exhaust

Pressure characteristics curve

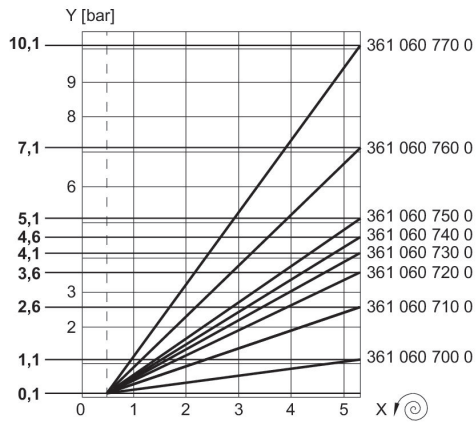

x = rotations of the handwheel
The characteristic curve can be moved parallel to the illustrated characteristic curve (in the y direction) using the screw cap.

Flow rate characteristic, p2 = 0,05 - 7 bar

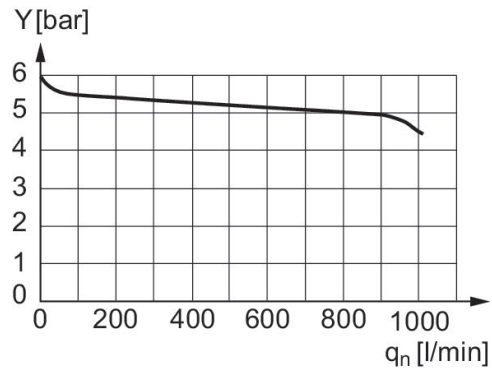

input pressure: 8 bar, supply pressure: 6 bar y: pressure in line "A" [bar]