

AVENTICS Series FSG Flat suction grippers

AVENTICS Series FSG are round flat suction cups. FSG suction cups are the right choice for many standard applications with level, flat workpieces. Round, bellows suction cup with 2.5 folds for handling of extremely sensitive workpieces (optimum damping effect). Moreover, the special design of the folds permits use in systems with very short cycle times.



Technical data

Industry	Industrial
Min. ambient temperature	-10 °C
Max. ambient temperature	70 °C
Temporary ambient temperature (<30 s) min.	-30 °C
Temporary ambient temperature (<30 s) max.	120 °C
Compressed air connection	G 1/8
external diameter	20 mm
Holding force	15.5 N
Volume	0.8 cm ³
Max. curving on object R min	20 mm
Abrasion value according to DIN 535 16	100-120 mm ³
Hardness according to standard	55 ± 5 Shore A
Connection thread type	External thread
Material connector	Aluminum
Suction unit material	Acrylonitrile butadiene rubber
Delivery unit	1 piece
Weight	0.007 kg
Part No.	1820455070

Technical information

To be used on even and smooth to slightly rough surfaces.

Dimensions

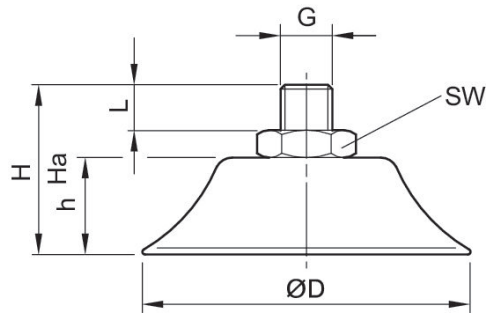

Part No.	$\varnothing D$	G	Ha*)	H	h	L	SW
1820455066	15	G 1/8	19.1	21	8	8	14
1820455070	20	G 1/8	20.7	23	10	8	14
1820455074	25	G 1/8	24	27	14	8	14
1820455078	28.8	G 1/8	23	25	12	8	14
1820455082	35	G 1/8	24	27	14	8	14
1820455086	40	G 1/8	23.5	27	14	8	14
1820455090	50	G 1/8	24	28	15	8	14
1820455094	60	G 1/4	28	33	18.5	10	17
1820455098	80	G 1/4	29	35	20.5	10	17
1820455102	95	G 1/4	29.5	35.5	21.5	10	17

*) Height for vacuum operation