

AVENTICS Series FSG Flat suction grippers

AVENTICS Series FSG are round flat suction cups. FSG suction cups are the right choice for many standard applications with level, flat workpieces. Round, bellows suction cup with 2.5 folds for handling of extremely sensitive workpieces (optimum damping effect). Moreover, the special design of the folds permits use in systems with very short cycle times.



Technical data

Industry	Industrial
Min. ambient temperature	-40 °C
Max. ambient temperature	80 °C
Temporary ambient temperature (<30 s) min.	-40 °C
Temporary ambient temperature (<30 s) max.	100 °C
Compressed air connection	G 1/4
external diameter	60 mm
Holding force	130 N
Volume	15 cm ³
Max. curving on object R min	75 mm
Abrasion value according to DIN 535 16	10-12 mm ³
Hardness according to standard	72 ± 5 Shore A
Connection thread type	External thread
low-wear	low-wear
Material connector	Aluminum
Suction unit material	Polyurethane
Delivery unit	1 piece
Weight	0.0211 kg
Part No.	1820415173

Technical information

To be used on even and smooth to slightly rough surfaces.

Flat suction gripper, Series FSG

2024-03-14

1820415173

Dimensions

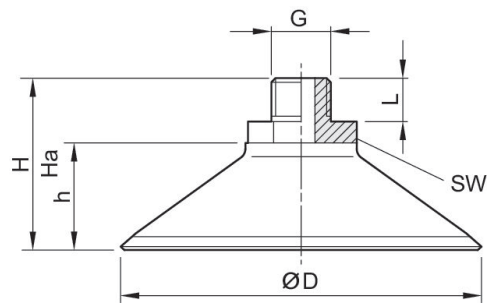

Part No.	ØD	G	H	Ha*)	h	L	SW
1820455012	14.5	G 1/8	22.5	21	9.5	8	14
1820455013	30	G 1/8	26	23	13	8	14
1820455015	50	G 1/4	32	27.5	17	10	17
1820415173	60	G 1/4	33.5	27.5	18.5	10	17
1820455018	80	G 1/4	40	34	25	10	22
1820455111	95	G 1/4	40	34	25	10	22

*) Height for vacuum operation