

AVENTICS Series FSG Flat suction grippers

AVENTICS Series FSG are round flat suction cups. FSG suction cups are the right choice for many standard applications with level, flat workpieces. Round, bellows suction cup with 2.5 folds for handling of extremely sensitive workpieces (optimum damping effect). Moreover, the special design of the folds permits use in systems with very short cycle times.



Technical data

Industry	Industrial
Min. ambient temperature	-10 °C
Max. ambient temperature	70 °C
Temporary ambient temperature (<30 s) min.	-30 °C
Temporary ambient temperature (<30 s) max.	120 °C
Compressed air connection	G 1/4
external diameter	95 mm
Holding force	350 N
Volume	35 cm ³
Max. curving on object R min	200 mm
Abrasion value according to DIN 535 16	100-120 mm ³
Hardness according to standard	55 ± 5 Shore A
Connection thread type	Internal thread
Material connector	Aluminum
Suction unit material	Acrylonitrile butadiene rubber
Delivery unit	1 piece
Weight	0.1049 kg
Part No.	1820455101

Technical information

To be used on even and smooth to slightly rough surfaces.

Dimensions

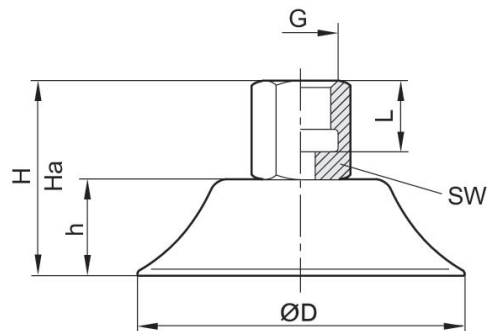

Part No.	ØD	G	Ha*)	H	h	L	SW
1820455065	15	G 1/8	22.1	24	8	13	14
1820455069	20	G 1/8	23.7	26	10	13	14
1820455073	25	G 1/8	27	30	14	13	14
1820455077	28.8	G 1/8	26	28	12	13	14
1820455081	35	G 1/8	27	30	14	13	14
1820455085	40	G 1/8	26.5	30	14	13	14
1820455089	50	G 1/8	27	31	15	13	14
1820455093	60	G 1/4	34	39	18.5	11	17
1820455097	80	G 1/4	37	41	20.5	11	17
1820455101	95	G 1/4	35.5	41.5	21.5	11	17
1820415165	120	G 1/2	30.5	36.5	23.5	13	-
1820415167	147.5	G 1/2	36.5	45.5	31	13	-

*) Height for vacuum operation