

## AVENTICS Series FSO Flat suction grippers

AVENTICS Series FSO are a range of oval flat suction cups ideal for long and cylindrical workpieces. Thanks to their oval shape, the contact surface available for establishing the vacuum is increased and optimized.

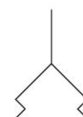

## Technical data

Industry	Industrial
Min. ambient temperature	-30 °C
Max. ambient temperature	180 °C
Temperature resistance	Heat resistant
Temporary ambient temperature (<30 s) min.	-50 °C
Temporary ambient temperature (<30 s) max.	220 °C
Compressed air connection	G 1/4
Holding force	50.1 N
Volume	2.3 cm <sup>3</sup>
Max. curving on object R min	20 mm
Abrasion value according to DIN 535 16	180-200 mm <sup>3</sup>
Hardness according to standard	60 ± 5 Shore A
Connection thread type	External thread
Material connector	Aluminum
Suction unit material	Fluoromethyl silicone
Delivery unit	1 piece
Weight	0.018 kg
Part No.	1820415134

# Oval suction gripper, Series FSO

2024-03-14

1820415134

## Technical information

To be used on long, flat, and slightly curved surfaces.

## Dimensions

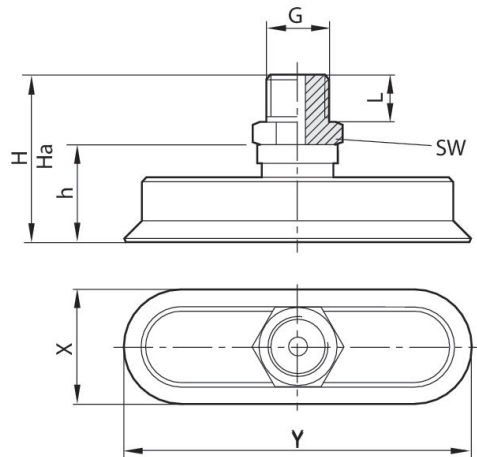

Part No.	G	X	Y	Ha*)	H	h	L	SW
1820415129	M5	5	15	21.3	22	12	5	8
1820415130	M5	6	18	21.2	22	12	5	8
1820415131	G 1/8	8	24	24	25	12	8	14
1820415132	G 1/8	10	30	23.5	25	12	8	14
1820415133	G 1/4	15	45	34	36	21	10	17
1820415134	G 1/4	20	60	33.5	36	21	10	17
1820415135	G 1/4	25	75	33.2	36	21	10	17
1820415136	G 1/4	30	90	32.5	36	21	10	17

\*) Height for vacuum operation